



User Guide

# PREPBOX A3XXX

**CHROMATOGRAPHY SEPARATION SYSTEM**



Document properties	
File:	Manual-PREPBOX-A3xxx-en-00.doc
Number of pages:	83
File size:	10716 kB
Last save:	7/13/2023 9:40:00 AM Kateřina Kněžourková

Ver.	Date	Author	Approved by	Description
00	11.07.2023	Kateřina Kněžourková	Jakub Hodaň	The first edition.

Related documents	
Manual-ECP2300_ECP2200	Manual-ECP201L_ECP201LG
Manual-TOY18_20DAD_HK_H	Manual-ECVA2000
Manual-ECOMAC	

**OBSAH:**

<b>1. GENERAL INFORMATION.....</b>	<b>5</b>
1.1. Product Function.....	5
1.2. Produced Versions.....	5
1.3. Accessories .....	6
<b>2. GENERAL OPERATING INSTRUCTIONS .....</b>	<b>9</b>
Safety Symbols on Unit .....	9
<b>3. DESCRIPTION .....</b>	<b>10</b>
<b>4. INSTALLATION .....</b>	<b>13</b>
4.1. Unit Placement.....	13
4.2. Tubing Installation into Sample Dosing Pump 300 ml/min .....	14
4.3. Tubing Installation into and from Gradient Valve .....	14
4.4. Sample Tubing Installation into Sample Switching Sample .....	14
4.5. Column Holder Construction .....	15
4.6. Column Installation and Tubing Installation.....	16
4.7. Tubing Installation into and from Detector.....	16
4.8. Tubing Installation from Fraction Collector.....	17
4.9. Piston Backwash .....	18
4.9.1. Simple Manual Use .....	19
4.9.2. Automatic Backwash .....	19
4.10. Waste Connection .....	20
4.10.1. Gradient Solvent Pump Leakage .....	20
4.10.2. ECLM2000 Leakage module.....	21
4.11. Connection on Unit Rear Panel.....	22
4.12. Startup of Unit.....	24
4.13. Pump Initiation.....	24
<b>5. CONTROL FROM PC.....</b>	<b>25</b>
<b>6. CONTROL USING ECOMAC SOFTWARE .....</b>	<b>25</b>
6.1. Unit Detection .....	26
6.2. Unit Parameters Setup .....	28
6.2.1. Unit Parameters Pumps .....	29
6.2.2. Unit Parameters Sample Switching Valve.....	31
6.2.3. Unit Parameters Detector.....	32
6.2.4. Unit Parameters Fraction Collector .....	34
6.2.5. Unit Parameters ECLM2000 Leakage module.....	36
6.3. Initiation of Communication with Unit.....	38
6.4. On-line Configuration of Unit .....	38
6.4.1. On-line Configuration of Pump.....	38

6.4.2. On-line Configuration of Sample Switching Valve.....	41
6.4.3. On-line Configuration of Detector.....	43
6.4.4. On-line Configuration of Fraction Collector.....	45
6.4.5. On-line Configuration of ECLM2000 Leakage module.....	47
<b>6.5. Method Setting Configuration.....</b>	<b>48</b>
6.5.1. Time Table Configuration.....	48
6.5.2. Fraction Table Configuration.....	52
6.5.3. Example Method.....	54
<b>6.6. Running and Stopping of Analysis.....</b>	<b>55</b>
<b>6.7. Deinitiation of Communication with Unit.....</b>	<b>55</b>
<b>7. SERVICE.....</b>	<b>55</b>
7.1. Replacement of Line Fuse.....	55
7.2. Parts Replacement.....	56
7.2.1. Pump 300 ml/min Seals.....	56
7.2.2. Pump 1000 ml/min Seals.....	58
7.2.3. Pump 300 ml/min Check Valves.....	60
7.2.4. Pump 1000 ml/min Check Valves.....	61
7.2.5. Pump 300 ml/min and 1000 ml/min Needle of Degassing/Purging Valve.....	63
7.2.6. Pump 300 ml/min and 1000 ml/min O-ring and Seal in Degassing/Purging Valve.....	63
7.2.7. Pistons.....	64
7.2.8. Deuterium Lamp (D2).....	64
7.2.9. Halogen (Tungsten) Lamp (W).....	66
<b>8. TROUBLESHOOTING.....</b>	<b>68</b>
<b>9. MAINTENANCE.....</b>	<b>70</b>
9.1. Period.....	70
9.2. Cleaning and Decontamination.....	70
9.3. Storage and Transport.....	70
9.4. Checking Tubing.....	70
9.5. Cleaning Check Valves.....	70
9.6. Cleaning Cell Windows.....	70
<b>10. SPARE PARTS AND ACCESSORIES.....</b>	<b>71</b>
<b>11. WARRANTY AND POST-WARRANTY REPAIRS.....</b>	<b>76</b>
<b>12. CELL.....</b>	<b>77</b>
12.1. Preparative cell PLCC 3L L.....	77
<b>13. TECHNICAL PARAMETERS.....</b>	<b>78</b>
<b>14. APPENDIX 1 – DECLARATION OF CONFORMITY.....</b>	<b>81</b>
<b>15. APPENDIX 2 – PREPBOX A338E / A3L8E WITH ADDITIONAL SWITCHING VALVE.....</b>	<b>82</b>

## 1. GENERAL INFORMATION

This unit is intended for use in laboratories for performing chromatographic methods (preparative HPLC). The compact system includes a UV-VIS detector, preparative gradient pump, preparative isocratic pump for sample dosing and automatic sample switching valve for CCC (Countercurrent Chromatography), FCPC (Fast Centrifugal Partition Chromatography) and CPC (Centrifugal Partition Chromatography) application and fraction collector.

### 1.1. Product Function

The unit allows the collection of samples of liquid outflowing from the detector, which is supplied by the pump, measurement of light absorbance at up to four wavelengths at one time or scanning through the entire spectrum. The sample is collected into collection containers. The sample collection is based on the selected collection mode through selector valve with 10 positions (which switches between sample liquid part collection into container and liquid part into waste). Collection can be performed in time mode when all sample is collected or is collected base on signal value of connection device. Depending on the version, it can be equipped with one of three detectors with the wavelength 200-400/600/800 nm. A deuterium lamp combined with a halogen lamp is used as the light source. It is equipped with one of two preparative pump types with flow rates up to 300 or 1000 ml/min. The pumps are double-acting with two pump blocks connected in parallel. Both working heads are fitted with inlet and outlet check valves. The smooth flow of the mobile phase is ensured by suitable shaping of the driving cams. The cams ensure the uniform movement of the ceramic pistons pumping under counterpressure, and, at the same time, precise control of the motor rotation is achieved. The pump works in the system as isocratic and gradient. The gradient valve is a standard 4-channel valve. The second sample dosing pump with a flow rate of 300 ml/min operates as above. It is used for sample dosing using a 4-way sample switching valve to the column. The solvent pump with the gradient valve is connected to this sample switching valve, too. The unit can be controlled through an internal PC to which is connected a keyboard with a mouse and a monitor, notebook or other computing device capable of communicating with the internal computer.

### 1.2. Produced Versions











PREPBOX A3L8E – Chromatography separation system, gradient pump 1000 ml/min and 300 ml/min, 200–800 nm, scanning  
Cat.No.: SCK0000X









PREPBOX A338E – Chromatography separation system, gradient pump 300 ml/min and 300 ml/min, 200–800 nm, scanning  
Cat.No.: SCKA000X

### 1.3. Accessories

**BASIC – COMMON FOR ALL VERSION**

P/N	Mn.	Obr.	Popis
EKAB-011	1		Mains supply cable 10A-250V 2 m EU (certified cable type is inserted according to order)
EKAB-031	1		Mains supply cable 10A-250V 2 m US/CAN (certified cable type is inserted according to order)
EKAB-060	1		Mains supply cable 10A-250V 2 m UK (certified cable type is inserted according to order)
23987	1		Tube fuse T – 6,3A/250V, CSA (power main unit fuse; for combined power socket with power main switch and power main fuse)
EKAB-041	1		LAN cable 3 m (to connector LAN)
EK-109	1		Terminal block 8 pins green (for connector IO INTERFACE)
ANA95000	1		Testing cell in bracket ZK04L (for testing detector and cell functionality)
ACE98000	1		FEP inlet tubing 3/16" 1000 mm with filter 20 μm and lid (FEP tubing, ID=1/8", volume = 7.9 ml only tubing, 2x PEEK nut 3/16", thread 5/16"-24, PP lid on tray GL45 with PA plug with tubing holes, PE filter 20 μm No-Met with reduction UNF 5/16", 2x Tefzel ferrule 3/16", <b>for inlet sample dosing pump 300 ml/min</b> )
ACE98000	4		FEP inlet tubing 3/16" 1000 mm with filter 20 μm and lid (FEP tubing, ID=1/8", volume = 7.9 ml only tubing, 2x PEEK nut 3/16", thread 5/16"-24, PP lid on tray GL45 with PA plug with tubing holes, PE filter 20 μm No-Met with reduction UNF 5/16", 2x Tefzel ferrule 3/16", <b>for gradient valve to solvent pump 300 ml/min</b> )
SCK43000	4		FEP inlet tubing 1/4" 2000 mm (FEP tubing, ID=5/32", volume=24.9 ml only tubing, 1x CTFE nut 1/2", 1x CTFE ferrule 1/4", thread 1/2"-20 UNF, <b>for gradient valve to solvent pump 1000ml/min</b> )
PN000080	2		Waste tubing with adapter 3/32" (silicone tubing 1 m, adapter Male Luer 3/32" Barb; from by-pass valve <b>to waste of solvent and sample pump</b> )

P/N	Mn.	Obr.	Popis
ABB22000	1		<b>FEP tubing 3/16" 300 mm connecting gradient valve with pump 300 ml/min</b> (FEP tubing, ID=1/8", volume= 2375 µL; 2x PEEK nut 3/16", 2x Tefzel™ fitting 3/16", thread 5/16"-24 UNF; <b>for gradient valve outlet to solvent pump 300 ml/min</b> )
SCK49000	1		<b>FEP tubing 1/8" 2000 mm sample tubing into sample switching valve</b> (FEP tubing, OD=1/8", ID=1/16", volume = 4 ml µL, 1x PEEK nut 1/8", UNF 5/16"-24)
SCK44000	1		<b>Capillary 1/8" 1000 mm connecting switching valve with column</b> (stainless steel capillary, OD=1/8", ID=2.1 mm, volume = 3,5 ml, 2x stainless steel nut 1/8", UNF 5/16"-24, 2x stainless steel ferrule 1/8")
SCK45000	1		<b>FEP tubing 1/8" 1000 mm connecting switching valve with column, Luer Lock</b> (FEP tubing, OD=1/8", ID=1/16", volume = 2 ml, 1x PEEK nut 1/8", UNF 5/16"-24; 1x PEEK nut 1/8", UNF 1/4"-28, 1x KEL-F ferrule 1/8", PEEK adapter female to Luer Lock male, UNF 1/4"-28, bore 1.3 mm)
SCK46000	1		<b>FEP tubing 1/8" 1000 mm connecting column with detector</b> (FEP tubing, OD=1/8", ID=1/16", volume = 2 ml, 1x PEEK nut 1/8", UNF 5/16"-24; 1x PEEK nut 1/8", UNF 5/16"-24, 1x KEL-F ferrule 1/8")
SCK47000	1		<b>FEP tubing 1/8" 1000 mm connecting column with detector, Luer Lock</b> (FEP tubing, OD=1/8", ID=1/16", volume = 2 ml, 1x PEEK nut 1/8", UNF 1/4"-28, 1x KEL-F ferrule 1/8", PEEK adapter female to Luer Lock female, UNF 1/4"-28, bore 1.3 mm, 1x PEEK nut 1/8", UNF 5/16"-24, 1x PEEK ferrule 1/8")
SCK48000	1		<b>FEP tubing 1/8" 350 mm connecting detector with 10 position valve</b> (FEP tubing, OD=1/8", ID=1/16", volume = 0.7 ml, 1x PEEK nut 1/8", UNF 1/4"-28, 1x KEL-F ferrule 1/8" 1x PEEK nut 1/8", UNF 5/16"-24, 1x PEEK ferrule 1/8")
AVV11010	10		<b>FEP tubing 1/8" 1500 mm connecting from 10 position valve</b> (FEP tubing, OD=1/8", ID=1/16", volume = 3 ml, 11x PEEK nut 1/8", UNF 1/4"-28, 11x CTFE ferrule 1/8")
AFA94000	1		<b>Waste set</b> (silicone tubing ID 0,25" x OD 0,375", connector L 1/4" Qosina)
ECS90100	2		<b>Piston back washing set for pumps 300 ml/min and 1000 ml/min</b>

P/N	Mn.	Obr.	Popis
ECS90090	1		Column holder set for chromatography separation system (rod holder, a rod for a clamp holding, double cross clamp, laboratory clamp for system, 5 pcs. M4x20 Torx pan head screw A2)
LSE20000	2		External leakage ECOM (cable length 2 m)
18329000	1		Screwdriver Torx T10 S2 FESTA (for halogen lamp exchange)
18331000	1		Screwdriver Torx T20 S2 FESTA (for mounting the column holder and fixing the column rod; mounting the heads when replacing seals)
990395	1		Open End Wrench 3/8" – 7/16" (loosing capillary while replacing check valves)
990383	1		Open End Wrench 8-10 mm (loosing nuts while replacing seals, check valves, o-ring or needle)
990389	1		Open End Wrench 11–12 mm (loosing nuts check valves, ECP201L)
990403	1		Open End Wrench 5,5 – 7 mm (when mounting halogen lamps)
DOC00004	1		Flash disk with User Manual
DOC00002	1	-	Production protocol

*Flow--cell PLCC 3LL in bracket (P/N ANA9203X) is included in the unit. List of other preparative cells is provided in Chapter 10.*



## 2. GENERAL OPERATING INSTRUCTIONS

Caution:	If the unit is used in a manner not specified by the manufacturer, the protection provided by the unit may be impaired!
Caution:	If the unit leaking, do not use it.
Caution:	Do not replace detachable power supply cables by inadequately rated cables.
Caution:	Do not place unit or any other equipment which would impair unplugging the power cable in the event of emergency.
Caution:	Never dismount the unit cover. There is nothing covered by it which needs customer servicing or maintenance.
Caution:	The pump is filled with isopropanol after assembly and servicing.
Caution:	When using buffers or other crystalizing agents in mobile phases, you must manually backwash the pistons.
Caution:	UV light is dangerous for eyes. During regular operation of the detector, the UV light is perfectly shielded. While exchanging the cell, never look into the cell area. Always keep at least a test cell in the detector. Always disconnect the power cable before exchanging the deuterium lamp.
Caution:	If the unit emits unusual noises, a burning odor, or smoke, immediately unplug the power cable and contact customer service.
Caution:	Only use the unit in accordance with the precautions for handling liquids. For information on the safety precautions when handling liquids, see the safety data sheets for each liquid. There is information about the explosive hazard of liquids transforming into gas.

### Safety Symbols on Unit

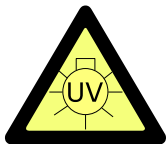

**UV light is dangerous to your eyes.** If the flow-cell is installed in unit then UV light is perfectly shielded. **In case you will handle the flow cell in any way, it is very important to protect your eyes with glasses or goggles certified to absorb UVC/UVB/UVA light.**



**Attention electrical hazard! Unplug the power cable before servicing the unit.**



**Electrical unit! Disconnect power cable before servicing. Read the User Manual before replacing fuse!**

### 3. DESCRIPTION

FRONT VIEW



No.	Description
1	Front switch.
2	USB connector.
3	Sample dosing pump 300 ml/min.
4	Inlet of sample dosing pump.
5	Outlet of sample dosing pump.
6	Washing/degassing (bypass) valve of sample dosing pump.
7	Gradient valve.
8	Gradient solvent pump 300 ml/min or 1000 ml/min.
9	Inlet of gradient solvent pump.
10	Outlet of gradient solvent pump.
11	Washing/degassing (bypass) valve of gradient solvent pump.
12	Leakage sensor.
13	Sample switching valve.
14	Inlet of capillary from gradient solvent pump.
15	Inlet of capillary from sample dosing pump.
16	Outlet to column.
17	Outlet of sample tubing.
18	Emergency drain with cone for connection of waste system coupling.

**RIGHT SIDE VIEW**



No.	Description
1	Flow cell
2	Fraction collector.
3	Light sources are found under a small cover. Open to replace the deuterium lamp and the halogen lamp (see chapter 2. General Operating Instructions).

**LEFT SIDE VIEW**



No.	Description
1	Gradient valve.
2	Inlet of gradient valve.
3	Outlet of gradient valve.

REAR VIEW



No.	Description
1	Main power supply.
2	IO Interface – Leakage module – from left side to right side – connector for external system, connector for 4 external leakage sensor A-D.
3	USB connectors.
4	HDMI connector.
5	VGA connector.
6	LAN connectors.
7	RS232 connectors.

## 4. INSTALLATION

### 4.1. Unit Placement

Place the unit in a suitable location that satisfies the following conditions:

- Set on a sturdy, stable horizontal surface
- Keep at least 10 cm space clear behind the rear of the system for ventilation.
- Keep away from equipment generating a strong magnetic field.
- Ensure sunlight does not shine directly on the unit.
- Note that equipment is intended for use in a regular laboratory environment only - see *Technical parameters – operating environment conditions*.

**Caution:** When the capillaries/tubing are connected, turn on the pump and check all connections for leaks! Check for potential leaking not only after unit installation but also during operation. The flow rate and pressure should be increased gradually to avoid sudden loosening of the tubing during a high flow rate (1000 ml/min).

PREPBOX LIQUID CONNECTION SCHEMA

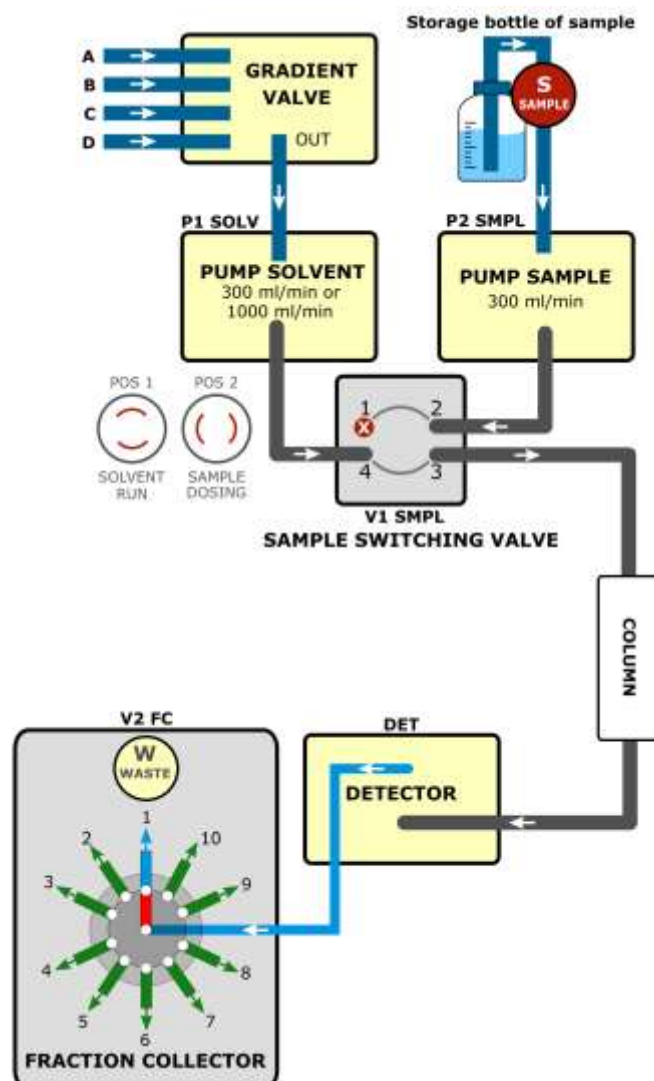

**Note:** Capillaries connecting the gradient solvent pump (SCK40000) and the sample dosing pump (SCK41000) with the sample switching valve are installed from the manufacture.

## 4.2. Tubing Installation into Sample Dosing Pump 300 ml/min



### Isocratic connection of a dosing pump inlet:

Connect the inlet tubing (ACE98000) with a nut and ferrule and place the other end of the tubing with a filter into a storage bottle containing the mobile phase. This is one of the unit accessories.

## 4.3. Tubing Installation into and from Gradient Valve



Connect the inlet tubing (ACE98000 for solvent pump 300 ml/min, SCK42000 for solvent pump 1000 ml/min) with a nut and ferrule and place the other end of the tubing into the storage bottle containing the mobile phase. This is one of the unit accessories.



Tubing (ABB22000 for solvent pump 300 ml/min, SCK42000 for solvent pump 1000 ml/min) connecting the outlet of the gradient valve and the inlet of the gradient solvent pump is pushed through the aluminum rail and is connected to the outlet of the valve. This is installed during assembly.

- Caution:** Make sure that the CTFE nut, along with the CTFE ferrule, is tightened sufficiently by hand. If the nut is tightened only slightly, the input tubing may become loose!
- Caution:** Inlet tubing inserted into the storage bottle containing the mobile phase must be fixed, so that it does not loosen during pumping.
- Caution:** Inlet tubing end inserted into the storage bottle containing the mobile phase must hang above the bottom to avoid stoppages.

## 4.4. Sample Tubing Installation into Sample Switching Sample

This tubing is intended for purging the sample from the system or flushing out the sample pump.

- Caution:** The sample switching valve has to be switched to POS 1 (SOLVENT RUN), see schema 4.1.



Connect the inlet sample tubing (SCK49000) with a nut to position 1 on the sample switching valve. Place the other end of the tubing to the storage bottle or waste. This is one of the unit accessories.

#### 4.5. Column Holder Construction

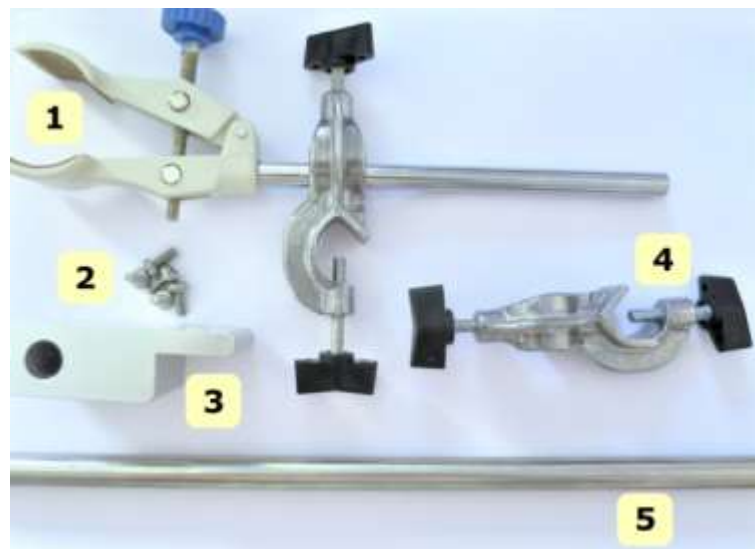

1- Laboratory clamp, 2- Screw TX M4x20 (5 pcs), 3- Column holder, 4- Crossed clamp, 5- Rod for clamp holding

Note: All parts used are included in the accessories.



Column holder is used to attach the outer column to the side of the unit. Holder is screwed with a TX20 screwdriver to the side of the U-profile using two TX M4x20 screws.



Cross clamp is fastened to the attached rod using a screw. The laboratory clamp is then mounted in the cross clamp. The column is fastened into the laboratory clamp.

#### 4.6. Column Installation and Tubing Installation



The whole set SCK44000 is among unit accessories.

Stainless steel capillary OD 1/8" 1 m (JR626-00) with 2x nuts UNF 5/16"-24 (00000160) and 2x ferrules (JRZF2S6) are included. One end connects to the sample switching valve and the second end connects to the column inlet.



The whole set SCK45000 is among the unit accessories.

Connect FEP tubing OD 1/8" 1 m (YY001) with 1x PEEK compact nut UNF 5/16"-24 (00000550) to the sample switching valve, 1x PEEK nut UNF 1/4"-28 (00000450) and 1x KEL-F ferrule (00000470) and 1x PEEK adapter female to Luer Lock male (bore 1.3 mm) (BG220304) to the column inlet.



Capillary or tubing is connected to the sample switching valve position 3 and the second end is connected to the column.

#### 4.7. Tubing Installation into and from Detector



The whole set SCK46000 is among the unit accessories.

Connect FEP tubing OD 1/8" 1 m (YY001), 1x PEEK compact nut UNF 5/16"-24 (00000550) to column outlet, 1x PEEK nut UNF 5/16"-24 with 1x PEEL yellow ferrule (YYP-130) to the detector inlet.



The whole set SCK47000 is among the unit accessories.

Connect FEP tubing OD 1/8" 1 m (YY001), 1x PEEK nut UNF 1/4"-28 (00000450) and 1x KEL-F ferrule (00000470) and 1x PEEK adapter female to Luer Lock female (bore 1.3 mm) (BG220302) to the column outlet, 1x PEEK nut 1/8" UNF 5/16"-24 with 1x PEEK yellow ferrule (YYP-130) to detector inlet.





The tubing is connected to the column outlet.



Tubing from the column outlet to the lower cell inlet is connected. The liquid must flow upward. If connected otherwise, it may result in problematic degassing of the cell.

**Note: In case of placing the instrument on direct sun light, penetration of stray light to the cell may occur. In such case protect the ends of the inlet tubing.**



The whole set SCK48000 is among the unit accessories.

Connect FEP tubing OD 1/8" 1 m (YY001), 1x PEEK nut UNF 5/16"-24 with 1x PEEK yellow ferrule (YYP-130) to the detector outlet, 1x PEEK nut UNF 1/4"-28 (00000450) and 1x KEL-F ferrule (00000470) to the fraction collector inlet.



Connect the outlet tubing to the thread on top of the cell and other end is connected to fraction collector inlet.

The above described setup is valid for every PLCC type cell suitable for this detector. For information on connecting other cells, please, consult the service center ([service@ecompro.cz](mailto:service@ecompro.cz) , +420 221 551 340).

#### 4.8. Tubing Installation from Fraction Collector

The fraction collector selector valve with 10 positions is a rotary valve. The inlet is in the middle of the valve. Around it, there are outlets around the inlet (see below). Position 1 is waste. It is the default setting, and its function cannot be changed. Positions 2-10 can be collected or sent to waste, which is dependent on the settings in Parameters (see 6.2.4).

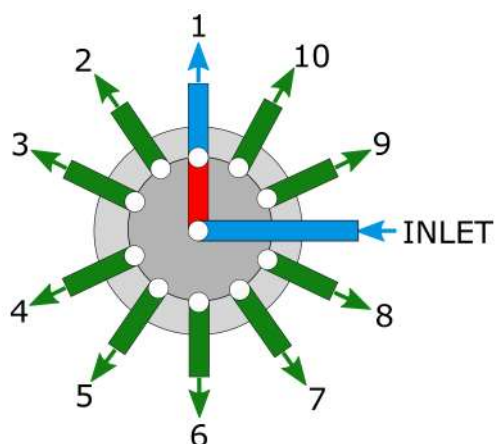

The arrows show the direction of flow.

**Caution:** After unpacking the fraction collector, do not remove the protective cap or tape from the valve ports until you are ready to install the valve. As supplied, all surfaces are clean and free of contaminants, and must be kept clean to prevent valve damage. Open ports and fittings cause unnecessary risk of particulate matter entering the valve and scratching the sealing surfaces, which is the most frequent cause of premature valve failure.



Use FEP outlet tubing OD 1/8" (AVV11010) and put on ferrules with colored nuts for the outlet. This is one of the unit accessories.

## 4.9. Piston Backwash

**Caution:** When using buffers or other crystallizing substances in mobile phases, you must backwash and rinse the piston.

**Note:** The piston back-washing set for the 300 ml/min sample dosing pumps and 300/1000 ml/min solvent pumps are among the unit accessories.

Each pumping block (left and right) has two heads – one for pumping and one for washing. The pumping heads are located farther from the unit. The washing heads have a connection to the piston backwash in the upper and lower parts of the slot with the Luer cone. Both heads are equipped with a seal (piston padding). During work with the buffer, solutions may buffer crystals adhering to the piston and may damage the seal. In this case, the pump can start leaking.

**SET FOR PISTON BACK WASHING**

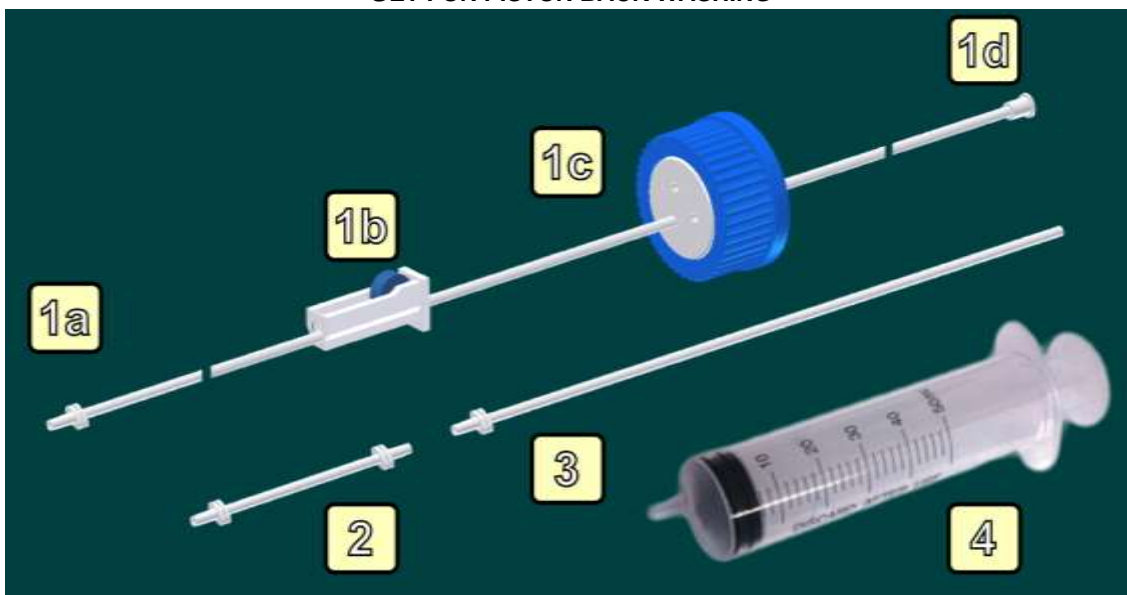

1. Inlet part; 1a. Luer cone for connecting to backwashing head; 1b. Flow regulator; 1c. Lid GL45 with plug; 1d. Luer cone for syringe connection; 2. Coupling of washing heads; 3. Outlet into waste system; 4. Syringe 50ml

**4.9.1. Simple Manual Use**

Connect both **washing heads** in series using tubing and Luer adapters. Fill a syringe with HPLC water (or mobile-phase dissolving buffers) and wash the heads. Fill the washing heads with liquid, and then rinse the pistons from the rear side. Now, once in a while during work with the pump, some liquid is pushed through the pump to the washing system (approx. 1x per hour).

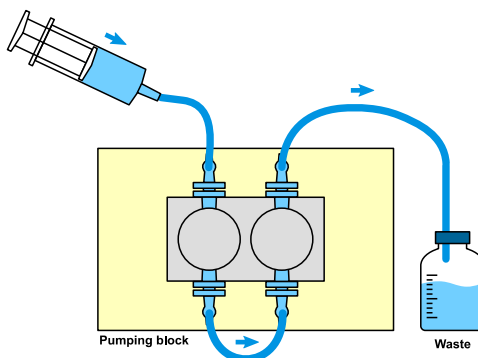

**4.9.2. Automatic Backwash**

Connect both **washing heads** in series using tubing and Luer adapters. Insert the tubing with a flow regulator into the reservoir with the HPLC water (or mobile-phase dissolving buffers). Loosen the flow regulator and suck the liquid into the system using a plastic syringe connected to the other end of the system (see picture on left below). Disconnect the syringe and place the tubing end into the waste reservoir. Now, the liquid flows through the system by gravity (see picture on right below). Set the flow regulator so that, at the end of the tubing, the flow escapes at approx. 5-7 drops per minute.

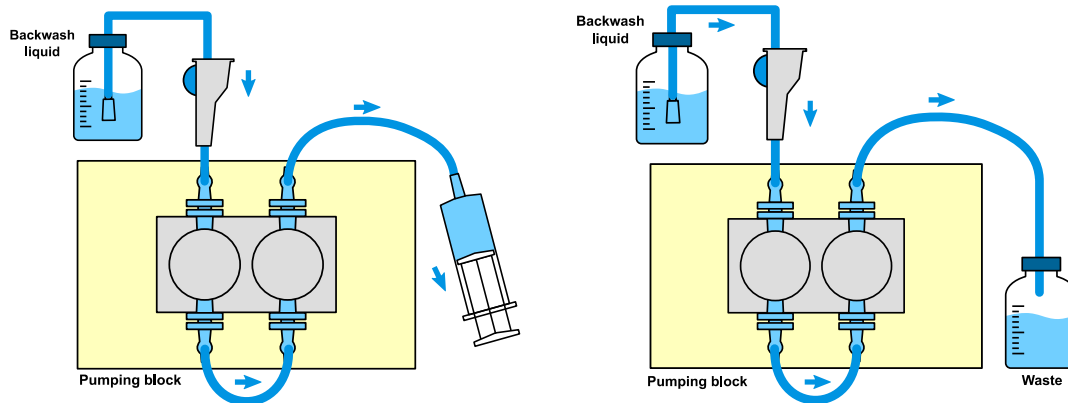

## 4.10. Waste Connection



Use silicone tubing with an L connector OD 0,375" is installed (AFA94000) and, for the outlet, put the L connector into the waste drain. This is one of the unit accessories.

### 4.10.1. Gradient Solvent Pump Leakage

The leakage sensor is composed of a reference sensor and a measuring sensor. If the measuring sensor is immersed in liquid, the sensor generates a signal. The processing of this signal depends on the actual setting.

When leakage occurs, it is necessary to eliminate the leakage source and to carefully dry the area surrounding the measuring sensor. After drying the sensor, it is necessary to wait at least 1 minute. Leakage sensor behavior is set for the solvent gradient pump (ECP2300 or ECP201LG) in the *Setup-Device* dialog of the *Parameter* table (see 6.2.1) of ECOMAC software.

#### SETTING OF LEAKAGE SENSOR BEHAVIOR

Setting	Behavior
OFF	Signal is ignored.
AS WARNING	A warning beeps and is displayed in the <i>Device on-line configuration</i> dialog – Decode warnings button (see 6.4.1). Default setting.
AS ERROR	Invokes a fatal error, so the pump stops and the unit goes into an initial idle state. The <i>Error message</i> dialog is opened and is displayed in the <i>Device on-line configuration</i> dialog – Decode warnings button (see 6.4.1).

### 4.10.2. ECLM2000 Leakage module

#### External Leakage Sensor

The unit allows for the connection of 4 external leakage sensors. These identify liquid leakage around the unit. This module works as a solvent pump leakage sensor, and it depends on the setting in ECOMAC software (see 6.2.5). Two external leakage sensors are among the unit accessories.

#### LEAKAGE SENSOR INSTALLATION

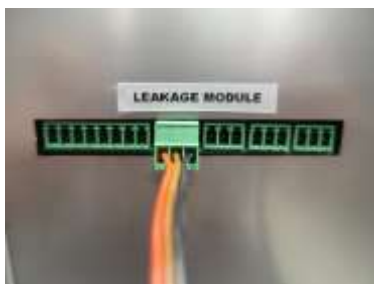

The green terminal block with 3-line cables plugs into the IO Interface on the rear panel (A-D position – from left to right). Leakage sensor is on the second end of cable. Cable is 2 m long.



The leakage sensor is attached to the selected liquid leak detection location so that lower diode is on the desktop. It is secured with tape.

**Caution:** Do NOT insert any screw (or any other foreign object) into the sensor body, because the sensor could be damaged.

#### Digital Input/Output of IO Interface

ECLM2000 Leakage module allows IO interface for digital input/output with different optional features (see 0).

#### IO INTERFACE SPECIFICATION

Pin	Abb.	Name	Description
1	+5V	-	Auxiliary power supply +5V max. 40 mA.
2	GND	-	Ground.
3	OUT1A	DIGITAL OUTPUT SWITCH 1	Semiconductor switching device 1, contact A and B. In basic state, it is disconnected. Working voltage max. 60 V. Working current max. 400 mA. Switch impedance ON max. 2 Ω. Residual current max. 1 μA.
4	OUT1B		
5	OUT2A	DIGITAL OUTPUT SWITCH 2	Semiconductor switching device 2, contact A and B. In basic state, it is disconnected. Working voltage max. 60 V. Working current max. 400 mA. Switch impedance ON max. 2 Ω. Residual current max. 1 μA.
6	OUT2B		

Pin	Abb.	Name	Description
7	DIN1	DIGITAL INPUT 1	Digital input 1. Compatible with TTL, HC, HCT. Overvoltage protection up to 24 V. There is pull-up resistor. In opened status it is on level H.
8	DIN2	DIGITAL INPUT 2	Digital input 2. Compatible with TTL, HC, HCT. Overvoltage protection up to 24 V. There is pull-up resistor. In opened status it is on level H.

For the external digital input/output interface, the IO INTERFACE uses connector green terminal block with screw-in contact (included in the unit accessories).

For connecting the cable to the connector block, loosen the nut using a small flathead screwdriver. Remove insulation from the end of the connected cable to approximately 3 to 4 mm in length. Insert the now uninsulated part of the cable into place under the nut and tighten the nut. Carefully check to ensure that the conductor is now securely held inside the connector block. If the stripped wire is too thin, it is better to remove the insulation again from a longer portion and bend the stripped part of the wire before inserting it into the connector block.

Note: Connector blocks are meant for cables with internal diameters up to 1.5 mm<sup>2</sup>.

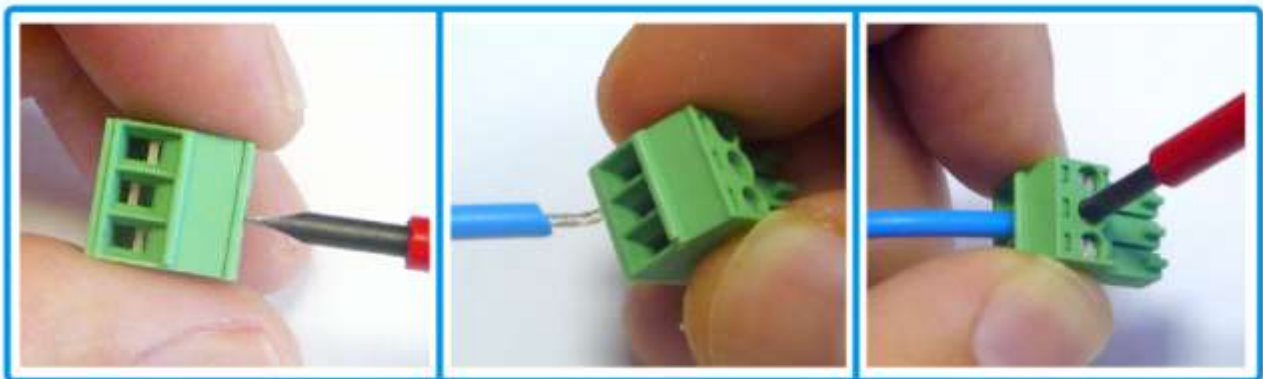

For digital inputs, the OPEN (H) value means opened input, high level, while CLOSE (L) means closed input, low level. For digital output, OFF (for open switch) and ON (for closed switch) are displayed.

#### 4.11. Connection on Unit Rear Panel



Plug the power supply cable into the power socket on the unit rear panel. The power supply cable is among the unit accessories.



Plug an ETHERNET network cable into the LAN connector. This is one of the unit accessories. Press the connector in until the safety pin snaps in. In order to unplug the connector, press the safety pin (see arrow on the right picture) and pull it out.

The other end of the network cable is plugged into the unit or computer network element.



The VGA connector connects to a PC monitor. This cable is not among the unit accessories.



The HDMI connector connects to a PC monitor. This cable is not among the unit accessories.



The USB 3.0 connector allows connecting a USB cable with a keyboard, mouse, flash disk, or Clarity key.

This cable is not among the unit accessories.



The USB 2.0 connector allows connecting a USB cable with a keyboard, mouse, flash disk, or Clarity key.

This cable is not among the unit accessories.



Plug a serial line cable into the RS232 connector for interconnection with other units.

This cable is not among the unit accessories.



Insert a terminal block into the LEAKAGE MODULE INTERFACE connector to connect to an external system. This item is one of the unit accessories. If there is no signal connected to the terminal block, it is not necessary to connect it.



Insert a terminal block into the LEAKAGE MODULE INTERFACE connector of the external leakage sensor. This item is one of the unit accessories. If there is no signal connected to the terminal block, it is not necessary to connect it.

## 4.12. Startup of Unit

Use the switch on the unit's rear panel to connect the unit to the electrical network, then switch on the unit using the push button on the unit's front panel. The push button glows red if the power source is off and green if the power source is on. If power supply is disconnected, the unit remembers the most recent status of this push button. After the power supply is reconnected, it restores the unit to its most recent status.

---

**Note:** After turning on the unit, wait approximately 15-30 minutes before starting the analysis. This ensures that the detector lamps warm up sufficiently (to stabilize the signal). Failure to do so may lead to erroneous analysis. Perform autozero.

**Note:** It is recommended to run in and stabilize the gradient and dosing pump before starting the analyses or after a longer shutdown of the unit at 100 ml/min at a pressure 5-10 MPa for about 15 min.

---

## 4.13. Pump Initiation

Both pumps are filled with isopropanol, it is necessary to **rinse it out** and fill the system with mobile phase and **degass** the entire system.



Loosen purge/degassing valve by turning it by 90°.

Slip a plastic syringe onto the purge/degassing valve. The syringe (50 ml) is part of pump accessories.

After closing of the purge/degassing valve, waste tubing (PN000080) can be insert to the valve.

This will loosen when aerating the pump.

Both pumps are connected to ECOMAC software (see 6). After their initiation, the *On -line Configuration* dialog (see 6.4) is opened. When the Purge... button is pressed and the *Purge dialog* is opened.



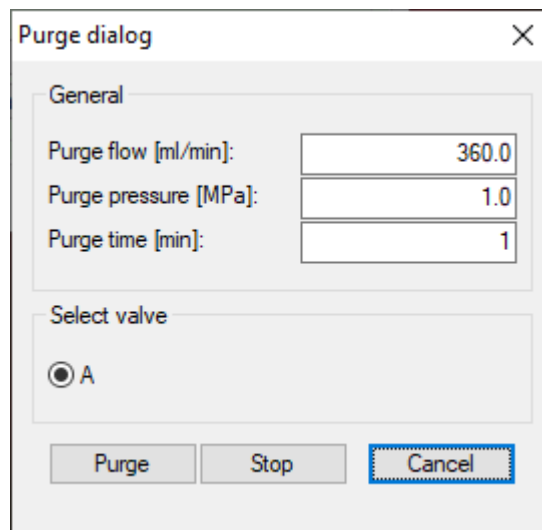

In gradient mode, you must check whether the appropriate valve (A, B, C, or D) with mobile phase is open. By pressing the Purge button, pump washing starts. The mobile phase with the plastic syringe is being sucked in as long as bubbles come out from the pump. It is possible to switch the valves during washing by pressing the channel in the *Select valve* dialog section. This allows the liquid to penetrate to all the necessary channels. Press the Stop button to stop the pump washing process. Tighten the purge/degas valve, take out the plastic syringe, and close the dialog.

## 5. CONTROL FROM PC

The unit contains a built-in PC board with installed ECOMAC chromatographic software for controlling the unit and Flash06Srv service software for controlling the detector. The unit provides VGA and HDMI connectors for connecting a monitor or projector. It also provides USB connectors for connecting a PC keyboard and mouse to the rear panel of the unit. Each unit of PREPBOX is connected to the internal PC board by RS232 connectors, which are controlled by ECOMAC software. The default connection to the unit's PC board via RS232 is used for:

- ECP2300 or ECP201LG (solvent gradient pump, P1\_SOLV) – COM7
- ECP2300 (sample dosing pump, P2\_SMPL) – COM8
- ECVA2000, DL4UW 2 position, 4 ports (sample switching valve, V1\_SMPL) – COM1
- TOY18DAD L (detector, DET) – COM5
- ECVA2000, C25-6180D 10 position, 11 ports, (fraction collector, V2\_FC) – COM2
- ECLM2004 (external leakage sensor, LEAKM) – COM6

## 6. CONTROL USING ECOMAC SOFTWARE

**Caution:** This manual contains a control description for the current version of ECOMAC software. Use the help in newer version of the software.

This short manual describes the most important and specific parts of control only. General information can be found in software's internal Help functionality *Help > Content*.

In C:\ECOMAC\methods, there are demonstration methods:  
 PREPBOX\_A3L8E\_template-01.mxl , PREPBOX\_A3L8E\_example-01.mxl.

PREPBOX\_A3L8E\_template-01.mxl is as default method with all units configured and the units parameters have the optimal setting. In the *Record* table of the *Setup – device* dialog, there are available and visible signals which are recorded after the initiation of communication. Each unit has own name which is written in the schema 4.1. The device name can be change in the *Miscellaneous* table of the *Setup – device* dialog.

**P1\_SOLV:** Solvent gradient pump is configurated as ECP2000 – model ECP201L (max. 1000 ml/min) or ECP2300 (max. 300 ml/min).

**P2\_SMPL:** Sample dosing pump is configurated as ECP2000 – model ECP2300 (max. 300 ml/min).

**V1\_SMPL:** Sample switching valve is configurated as ECVA2000, DL4UW – switching valve with 2 positions, 4 ports.

**DET:** Detector is configurated as TOY18 – model TOY18 DAD800-S scanning.

**V2\_FC:** Fraction collector is configurated as ECVA2000, C25-6180D –switching valve with 10 positions, 11 ports.

**LEAKM:** External leakage sensor is configurated as ECLM2000.

The description of Ecomac dialogs and how to work with software is in below chapters.

PREPBOX\_A3L8E\_example-01.mxl is as default example method (see 6.5).

## 6.1. Unit Detection

In the main menu, select *Method > Devices* after the application starts. In the *Available devices* list, select each of the following items 2x *ECP2000* (sample dosing pump, solvent gradient pump), *ECVA2000* (sample switching valve), *TOY18* or *TOY20* (detector), *ECVA2000* (fraction collector) and press spacebar (Add). This activates autodetection of this type of device in search operation. The unit will be available in righthand list after successful autodetection. If an external leakage sensor is used so it is selected *ECLM2000*. The gradient valve is controlled by solvent gradient pump.

When the demo method is used so this configuration need not be performed. An initiation of communication with units is only performed (see 6.3). The method is ready for work and preparing of the time table and the fraction table

METHOD SETTINGS DIALOG

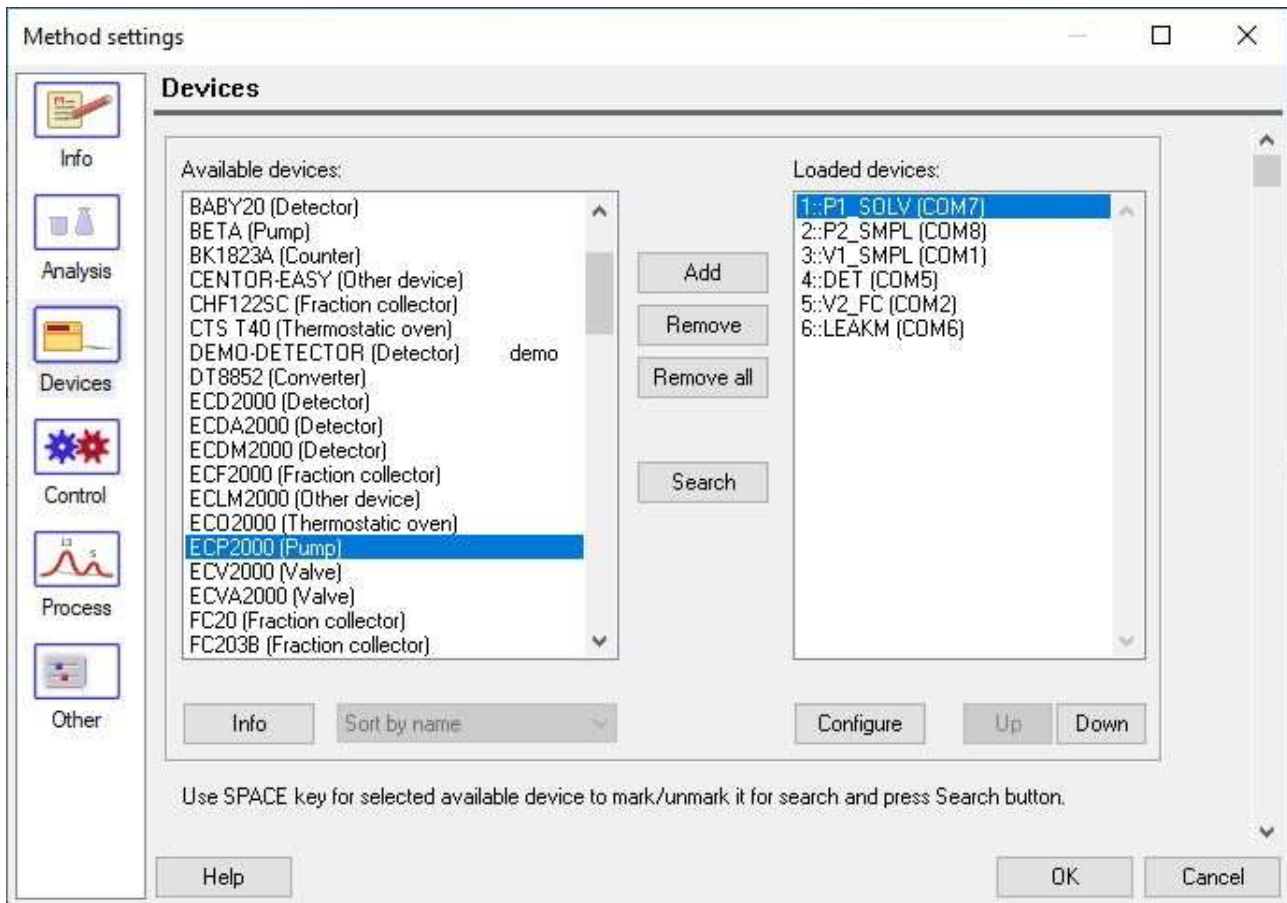

Double-click the unit in the *Loaded devices* list (or single-click and press the *Configure* button) to open the dialog with the *Communication* tab and others. It contains the standard setting, which is described in the internal *Help* section. Press the *Search* button.

**SETUP – DEVICE DIALOG**

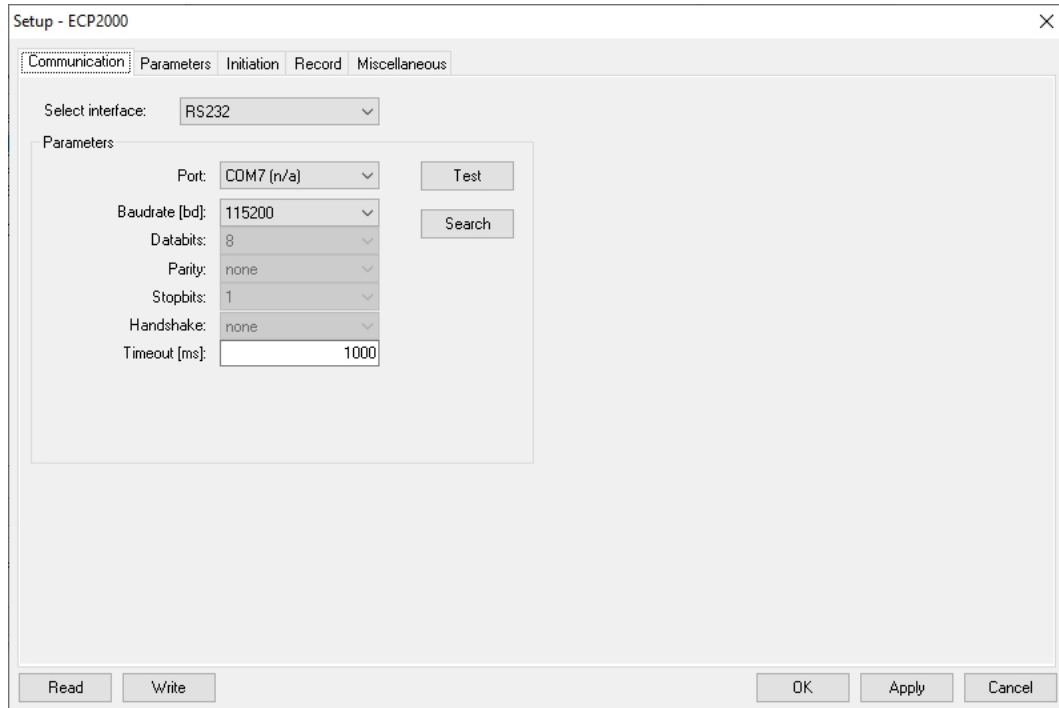

The *Device search* dialog is opened. All the units which have been found are shown. Choose the unit to configure. Each unit can be configured independently.

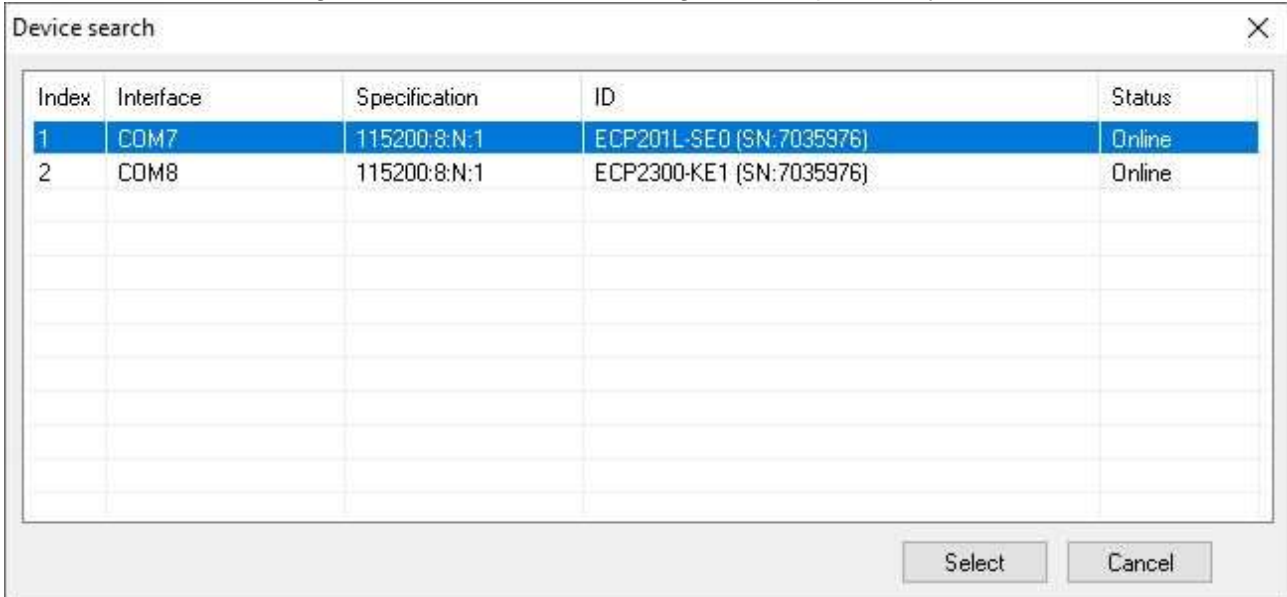

After selecting the unit, the *Message* dialog is opened with the question, “Do you want to read parameters from device?” Select either YES or NO. The *Setup – device* dialog is shown and the unit establishes a connection with the software.

**6.2. Unit Parameters Setup**

The setup parameters of unit will be set after the unit connects with the software. The *Parameters* table is on the second tab of the *Setup – device* dialog.

### 6.2.1. Unit Parameters Pumps

The *Parameters* table for ECP2000 is organized in the same way. This dialog has to be set for both pumps (i.e. the solvent pump and the sample dosing pump).

#### PARAMETERS SETTING OF SOLVENT GRADIENT PUMP / SAMPLE DOSING PUMP - P1\_SOLV/ P2\_SMPL

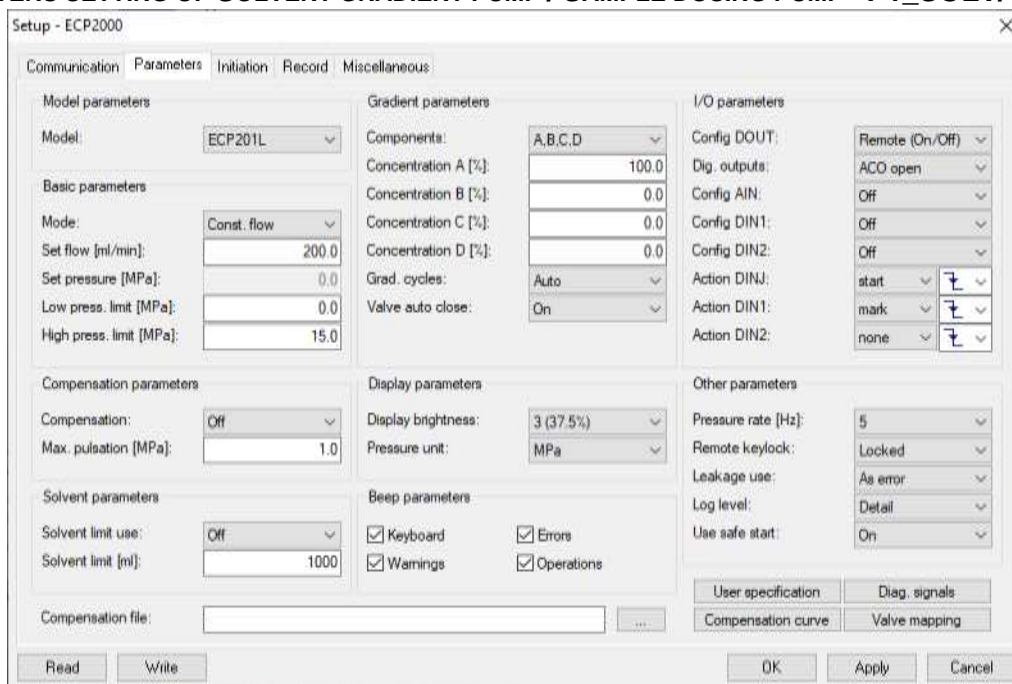

#### DESCRIPTION OF ITEMS

Tab	Parameter/Group	Description
Parameters	Model	Autodetected model of the device.
	Set flow [ml/min]	Set flowrate. Default is 60 ml/min ECP2300, 600 ml/min ECP201L
	Low press. limit [MPa]	Set low pressure limit in range 0-max. MPa pressure of pump. Default is 0 MPa.
	High press. limit [MPa]	Set high pressure limit in range 1-max. MPa pressure of pump. Default is max. pressure of pump-
	Compensation	Pulsation compensation function. <i>OFF</i> , <i>LEARNED 0 TMP</i> (Temporary – after turning unit off and on, learned process is canceled), <i>LEARNED 1 MEM</i> (Memory - after turning unit off and on, learned process is saves until new learning)
	Max. pulsation [MPa]	Pressure pulsation limit 0.1-5 MPa, default is 1 MPa.
	Solvent limit use	Setting of using solvent limit – <i>Off</i> , <i>As warning</i> , <i>As error</i> .
	Solvent limit [ml]	Solvent limit in storage bottle: 1-10,000 ml, default is 100 ml.

Tab	Parameter/Group	Description
	Components	Setting of active channel valve number.
	Concentration A-D [%]	Setting of channel concentration.
	Valve auto close	Setting of valves automatic closing without pumping. Choice <i>On</i> is closed or <i>Off</i> is opened.
	Display parameters	It is not supported.
	I/O parameters	It is not supported.
	Analog output parameters	It is not supported.
	Pressure rate [Hz]	Sample rate 1, 2, 5, 10, 20, 50, 100, 200, 500 Hz. Default value is 20 Hz.
	Leakage use	Setting of leakage sensor using and signaling mode - <i>Off, As warning, As error</i> . See 4.10.1.
Initiation	Startup parameters	Initial pump state will be used on connection with the unit.
	Stop parameters	Final pump state will be used on disconnection with the unit.
Record	Signal settings	Set channels which will be enable or visible in chromatograph.
Miscellaneous	Device name	Change of device name can be performed here. Default is name of device model.

*Other method settings are described in internal Help or Manual-ECP2200\_ECP2300, Manual-ECP201L\_ECP201LG.*

### 6.2.2. Unit Parameters Sample Switching Valve

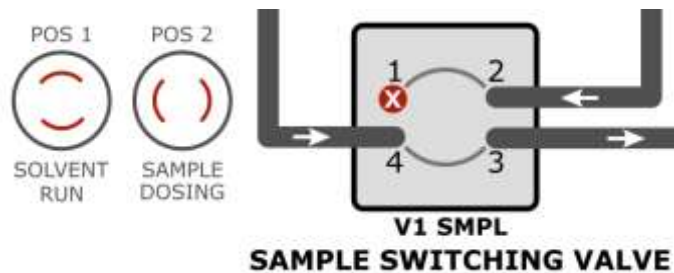

PARAMETERS SETTING OF SAMPLE SWITCHING VALVE – V1\_SMPL

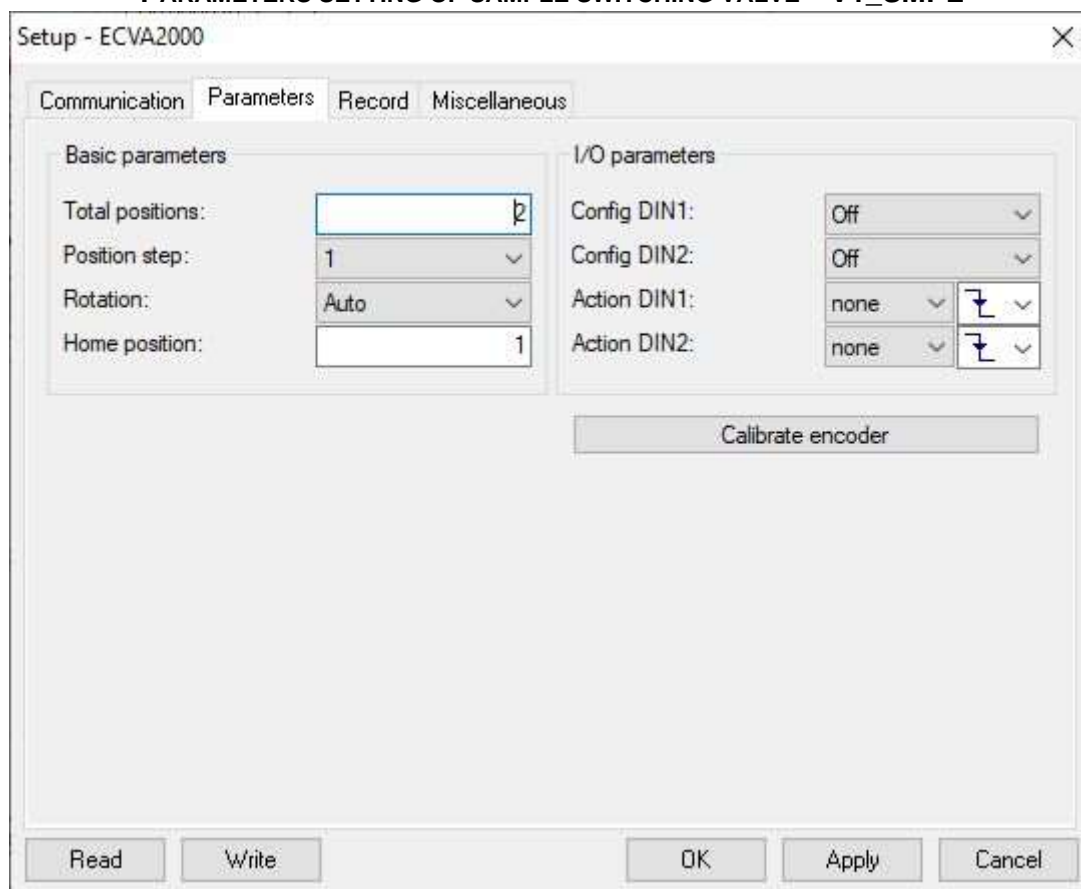

#### DESCRIPTION OF ITEMS

Tab	Parameter/Group	Description
Parameters	Total position	Number of valve positions (read only) – 2.
	Position step	<b>1</b> position is POS 1 – Solvent run, see schema above.
		<b>2</b> position is POS 2 – Sample dosing, see schema above.
	Rotation	Direction of valve rotation <b>Auto:</b> Shortest path <b>Clockwise:</b> Descending direction (1-4-3-2-1)
Home position	Home position of the valve.	

Tab	Parameter/Group	Description
	Pause during move	<b>On:</b> during valve move is done PAUSE of other unit in system (e.g. pump). It is default state. <b>Off:</b> during valve move is not done PAUSE other unit in system.
	Enable Online	<b>On:</b> manual change during analysis of valve position <b>can be done</b> during analysis. <b>Off:</b> manual change during analysis of valve position <b>cannot be done</b> during analysis. It is default state.
	I/O parameters	It is not supported.
	Calibrate encoder	Press the button to perform calibration.
Record	Signal setting	Set channels which will be enable or visible in chromatograph.
Miscellaneous	Device name	Change of device name can be performed here. Default is name of device model.

Other method settings are described in internal Help.

Note: Pressure is suddenly increased during valve move which can be higher than set value of high-pressure limit of pump. This case is useful to set *Pause during move – on*.

### 6.2.3. Unit Parameters Detector

#### PARAMETERS SETTING OF DETECTOR - DET

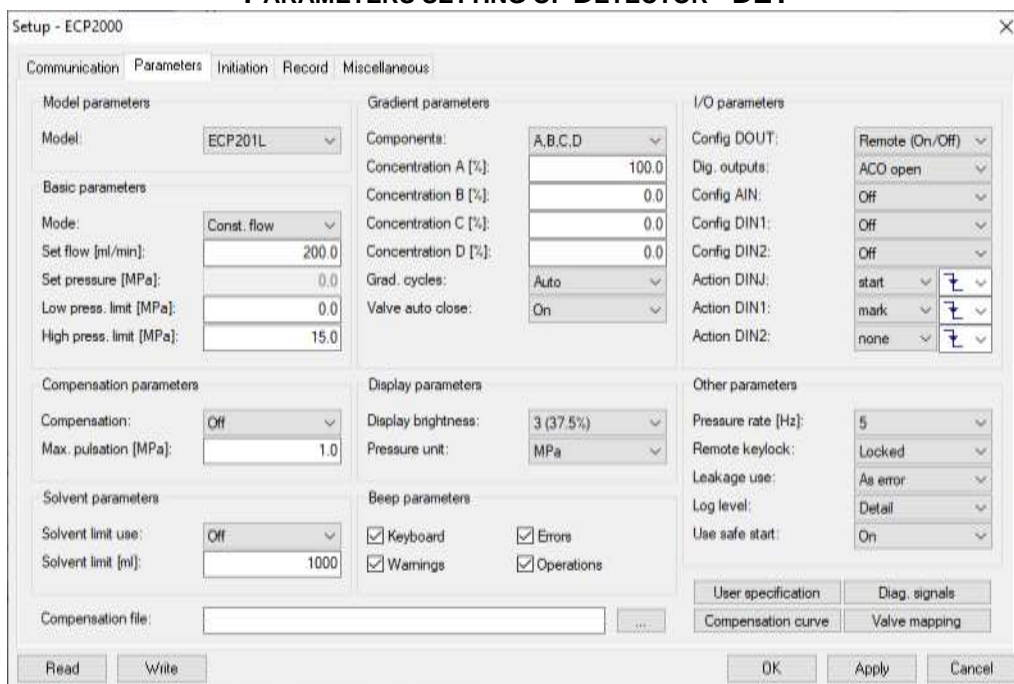

#### DESCRIPTION OF ITEMS

Tab	Parameter/Group	Description
Parameters	Model	Autodetected model of the device.



Tab	Parameter/Group	Description
	Sample rate [Hz]	Sample rate 1, 2, 5, 10, 20 Hz. Default value is 10Hz.
	Wavelength A-D [nm]	Set the wavelength on the channel.
	Band width [nm]	Electronic spectral resolution of the unit. Range of wl. 4 - 10 nm. Default value is 8 nm.
	Time constant	Time constant 0.1, 0.2, 0.5; 0.75; 1, 2, 4, 8 or 16 s.
	Negative range	Negative range of absorbance measuring – <i>Normal</i> (–0.1) AU is default value, <i>Medium</i> (–0.3) AU, <i>Higher</i> (–0.7) AU.
	Leakage use	It is not supported.
	Scan range [nm]	Range of scan operation. If it is set out of range it is automatically corrected on call of scan operation.
	Show text by	Show the text near 2 (4) selected wl. in scan. Options: <i>None</i> , <i>Wavelength</i> , <i>Value</i> , <i>Both</i> . Default value is <i>Value</i> .
	Show grids by	Setup grids show in scan. Options: <i>None</i> , <i>X</i> , <i>Y</i> , <i>Both</i> . Default value is <i>None</i> .
	Math parameters	The mathematical channel offers preset operations with channels A, B: $A+B$ , $A-B$ , $(A+B)/2$ , $(A-B)/2$ , $\max(A, B)$ , $-A$ , $ABS(A)$ , $A*M+O$ ( $FW \geq \sqrt{1.33}$ , $M$ =multiplier, $O$ =offset) (see in the detector user manual). The results are displayed in the field <i>Wavelength D [nm]</i> . The default value -- (none).
	Display parameters	It is not supported.
	Drift limiter parameters	Parameters setting of the drift compensation (see in the detector user manual).
	I/O parameters	It is not supported.
Analog output parameters	It is not supported.	
Initiation	Startup parameters	Initial lamp state will be used on connection with the unit.
	Stop parameters	Final lamp state will be used on disconnection with the unit.
Record	Signal settings	Set channels which will be enable or visible in chromatograph.
Miscellaneous	Device name	Change of device name can be performed here. Default is name of device model.

Other method settings are described in internal Help or Manual-TOY18\_20DAD\_HK\_H.

### 6.2.4. Unit Parameters Fraction Collector

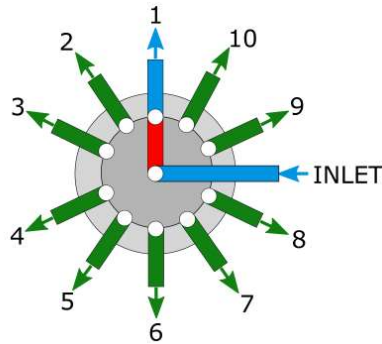

PARAMETERS SETTING OF FRACTION COLLECTOR – V2\_FC

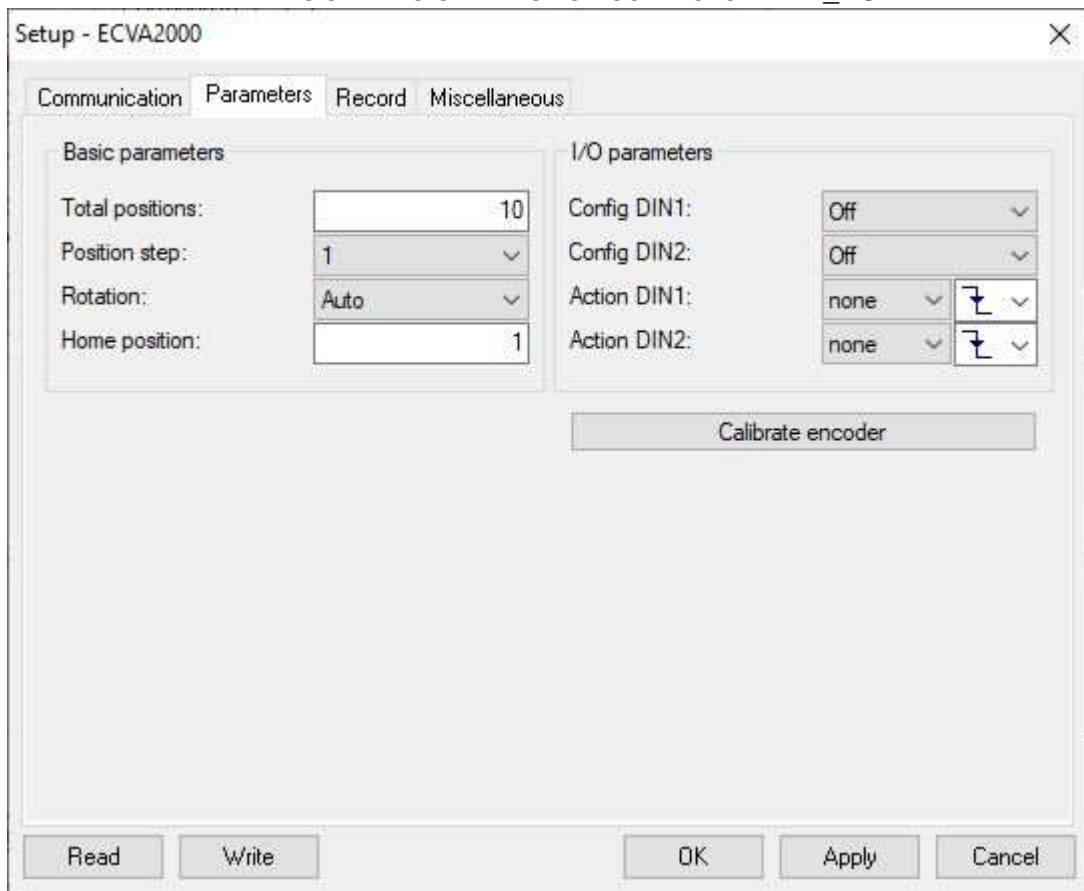

DESCRIPTION OF ITEMS

Tab	Parameter/Group	Description
Parameters	Total position	Number of valve positions (read only) – 10.
	Position step	<p><b>No. 1:</b> sample collection by step1. Position 1 is waste and position 2-10 are sample collection. There are 9 collection channels.</p> <p><b>No. 2:</b> sample collection by step 2. Position 2, 4, 6, 8, 10 = collect (C), position 1, 3, 5, 7, 9 = waste (W). There are 5 collection channels.</p>

Tab	Parameter/Group	Description
	Rotation	Direction of valve rotation <b>Auto:</b> Shortest path <b>Clockwise:</b> Descending direction.
	Home position	Home position of the valve.
	Pause during move	<b>On:</b> during valve move is done PAUSE of other unit in system (e.g. pump). It is default state. <b>Off:</b> during valve move is not done PAUSE other unit in system.
	Enable Online	<b>On:</b> manual change during analysis of valve position <b>can be done</b> during analysis. <b>Off:</b> manual change during analysis of valve position <b>cannot be done</b> during analysis. It is default state.
	I/O parameters	It is not supported.
	Calibrate encoder	Press the button to perform calibration.
Record	Signal setting	Set channels which will be enable or visible in chromatograph.
Miscellaneous	Device name	Change of device name can be performed here. Default is name of device model.

*Other method settings are described in internal Help.*

### 6.2.5. Unit Parameters ECLM2000 Leakage module

#### PARAMETERS SETTING OF EXTERNAL LEAKAGE SENSORS - LEAKM

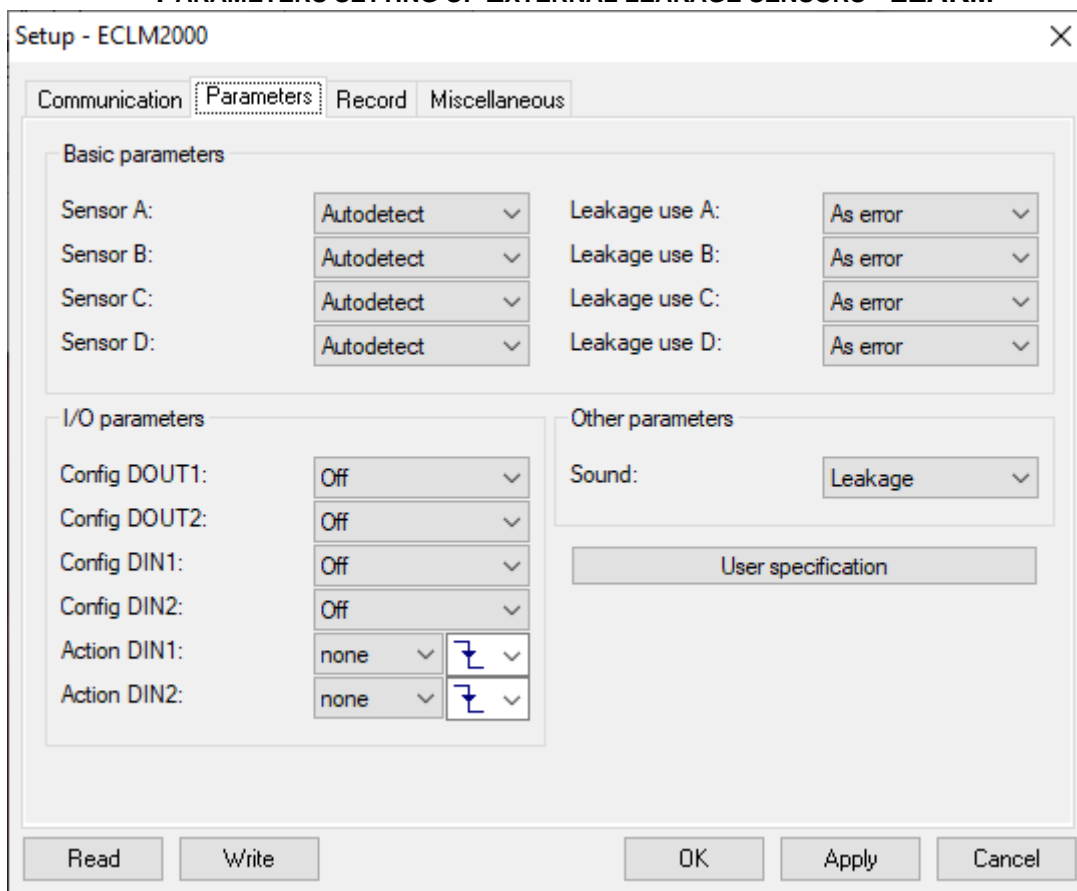

#### DESCRIPTION OF ITEMS

Tab	Parameter/Group	Description
Parameters	Sensor A-D	Usage settings of leakage sensors A-D. <i>Don't use, Use, Autodetect</i> (default is <i>Autodetect</i> ).
	Leakage use A-D	Setting of leakage reaction – <i>As warning, As error</i> (default is <i>As error</i> ).
	I/O parameters	<b>Config DOUT 1, 2:</b> <i>Off, On, Leakage sens. A-D, Leakage any, Leakage-error.</i> <b>Config DIN1, 2:</b> <i>Off, Reset meas., Disable sound.</i> <b>Action DIN1, 2:</b> <i>none, mark, start, stop, zero, C/W, spec, pause.</i> Default is <i>Off</i> for all one.
	Sound	<i>Off, Leakage, Leakage error</i> (default is <i>Leakage</i> ).
	User specification	There is place for writing of user specification.
Record	Signal settings	Set channels which will be enable or visible in chromatograph.
Miscellaneous	Device name	Default is name of device model.

*Other method settings are described in internal help.*

**SENSOR A-D SETTING**

Setting	Description
Don't use	Sensor is not used. The unit behaves as if it is not connected.
Use	Sensor is used if sensor is not connected or is disconnected during running so unit reports error.
Use autodetect	Sensor connection is automatically detected. Default setting.

**LEAKAGE A-D USE SETTING**

Setting	Description
As warning	Depending on the next setting, a sound is played or the digital output is turned on.
As error	Message is reported. Depending on the next setting, a sound is played or the digital output is turned on. Default setting.

**DIGITAL OUTPUT SWITCH 1,2 SETTING**

Setting	Description
Off	Digital output does not have any assigned action. Default setting.
On	Digital output is connected.
Leakage – sens A-D	Digital output is connected if liquid leakage is detected by sensor A – D.
Leakage any	Digital output is connected if liquid leakage is detected by any sensor.
Leakage - error	Digital output is connected if liquid leakage is detected by any sensor and its mode is set <i>Error</i> (see <i>Leakage use A-D</i> ).

**DIGITAL INPUT 1,2 SETTING**

Setting	Description
Off	Digital input does not have any assigned action. Default setting.
Enable leakage detection	Liquid leakage detection is only if digital input is connected.
Disable sound	If digital input is connected, sound signalization is switched off ( <i>Sound</i> mode is set on <i>Off</i> ).

**SOUND SETTING**

Setting	Description
Off	Sound is turned off.
Leakage	Sound is continuous if liquid leakage is detected with some sensor. Default setting.
Leakage error	Sound is continuous if liquid leakage is detected with some sensor and Leakage use A-D as error.

### 6.3. Initiation of Communication with Unit

Click on the  button in the main window. The program starts up communication with units and starts showing measured data. The measured data are shown, if *Initial lamp state* is set as *On*. Switching on/off of lamps is performed in a *Device on-line configuration* dialog (see next chapter).

### 6.4. On-line Configuration of Unit

Press the  button after the initiation of communication. The next dialog for parameters setting and checking will be opened. *Device on-line configuration* dialog is opened. Each device is shown on its own tab. Move between devices by clicking on a device name.

#### 6.4.1. On-line Configuration of Pump

ON-LINE CONFIGURATION OF SOLVENT GRADIENT PUMP / SAMPLE DOSING PUMP - P1\_SOLV / P2\_SMPL

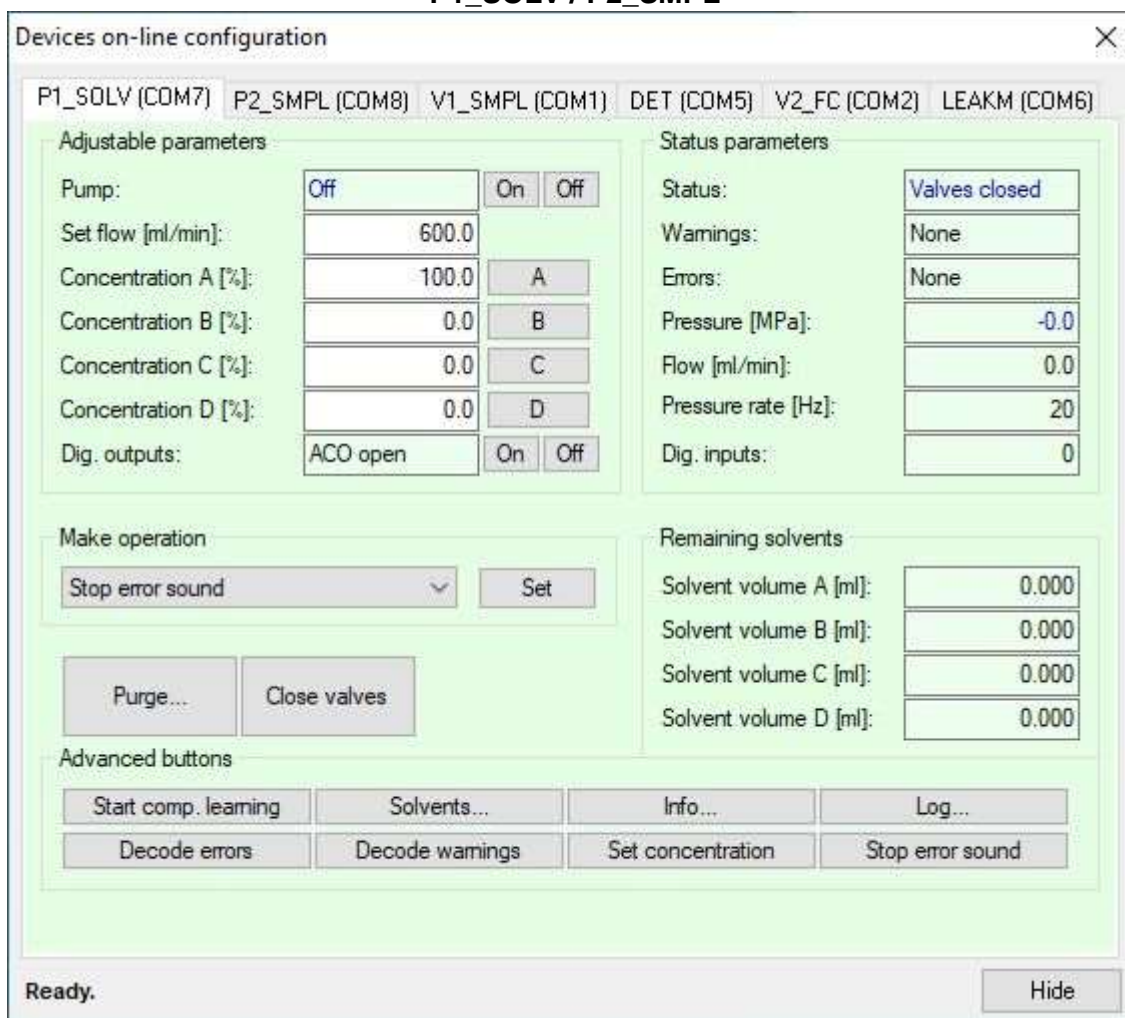

DESCRIPTION OF ITEMS

Group	Parameter	Description
Adjustable parameters	Pump	Shows pump state. Buttons <i>On/Off</i> starts and stops the pump.
	Set flow [ml/min]	Setting of flow rate.

Group	Parameter	Description
	Concentration A-D [%]	Current channel concentration.
Status parameters	Status	<i>Ready</i> - default state, ready to start. <i>Running</i> – pump is running. <i>Purge mode</i> – purge is running.
	Warnings/Error	Hexadecimal error code.
	Pressure [MPa]	Current pressure.
	Flow [ml/min]	Current flow.
	Pressure rate [Hz]	Pressure rate see 6.2.1.
Make operation	This operation is performed after making a selection and pressing the button Set.	
	Stop error sound	Turn off error signalization.
	Start comp. learning	Start compensation learning.
	Stop comp. learning	Stop compensation learning.
	Enable purge mode	Enable purge mode. Status is changed to <i>Purge mode</i> in <i>Status parameters</i> section. Purge is running by pressing On button in <i>Adjustable parameters</i> section and is stopped by pressing Off button.
	Disable purge mode	<i>Purge mode</i> is finished.
	Clear FIFO	Communication FIFO is deleted. It is for internal purposes.
	Close valves	Valve are closed when pump is stop. Valve automatic closing is set in <i>Parameters tab</i> , see 6.2.1.
	Quit program	Pump program are closed. This option is for pump with display.
	Valves by conc.	It is not supported.
	Test valves	Test of valves function.
Remaining solvents	Solvent volume A-D [ml]	Current storage bottle volume. <i>Solvent limit use</i> and <i>Solvent limit</i> is set in <i>Parameter tab.</i> , see 6.2.1.
Buttons	Purge...	<i>Purge dialog</i> is opened, see 4.13.
	Close valves	Manual closing of gradient valves. Default setting is auto closing valves.
Advanced buttons	Start comp. learning	Start/stop compensation learning. Mode of pulsation compensation is set in <i>Parameters tab.</i> , see 6.2.1.
	Solvent...	Setting of storage bottle volume for each channel. Refresh button is update state of solvent volumes. Set button is set the new volumes.

Group	Parameter	Description
	Info...	<i>Device info list.</i> All information about the unit. It is necessary for service diagnostics.
	Log...	<i>Device log list.</i> Record of all unit action (time limit of validity actions) and history of replacement parts, change of FW. It is necessary for service diagnostics.
	Decode errors	Show text of errors.
	Device warnings	Show text of warnings.
	Set concentration	Setting of channels concentration. Load button is update state of channel concentration. Apply button is set the new concentrations.
	Stop error sound	Stop error sound.

*More information about options is in Manual-ECP2200\_ECP2300, Manual-ECP201L\_ECP201LG.*

**Caution:**      **The *Device info list* and *Device log list* are generated for service purposes and sent to Ecom service support for diagnostics.**



### 6.4.2. On-line Configuration of Sample Switching Valve

#### ON-LINE CONFIGURATION OF SAMPLE SWITCHING VALVE – V1\_SMPL

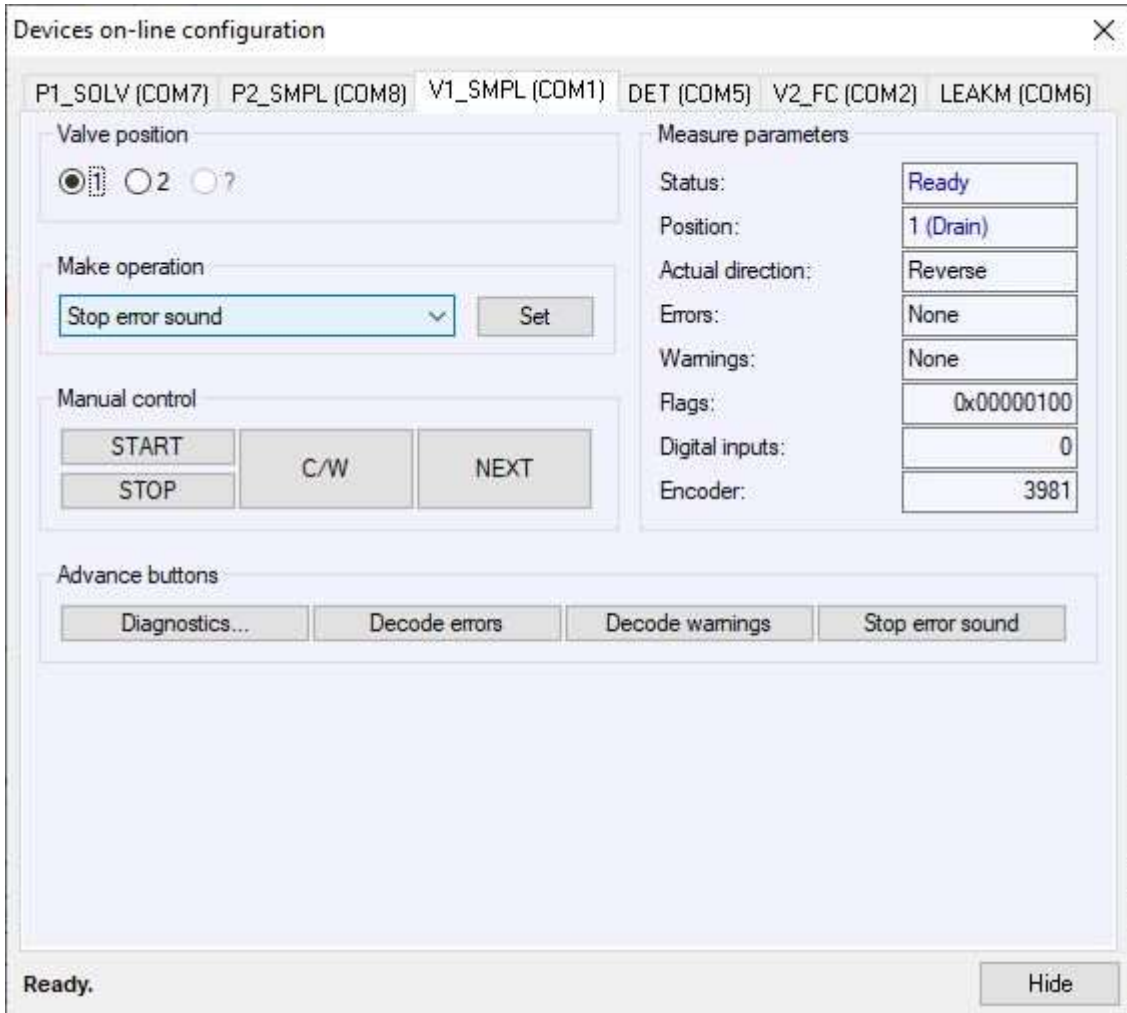

#### DESCRIPTION OF ITEM

Group	Parameter	Description
Valve position	1 - ?	Click on the field with the position number to turn the valve to that position. The question mark "?" indicates a closed position.
Make operation	This operation is performed after a selection is made and pressing the <i>Set</i> button.	
	Stop error sound	Stop error sound.
	Make a beep	Unit makes short beep by its internal speaker..
	Home position	Turn the valve to the home position.
	Increase position	Turn the valve to next higher position.
	Decrease position	Turn the valve to next lower position.
	Toggle position	Change the position of the two-position valve.
	Close valve	Turn the valve to the closed position.

Group	Parameter	Description
	Calibration	Perform calibration.
	Start	Valve is set to default position 1 (waste). Start of manual collection.
	Collects	Valve switched to collect.
	Waste	Valve switches to waste.
	Next	Valve rotated to next position (collect to next collect or waste to next waste).
	Stop	Valve is set to default position 1 (waste). Stop of manual collection.
	Make a test	It is not support.
Measure parameters	Status	Device state
	Position	Current valve position.
	Actual direction	Indicates direction of valve rotation. (If the rotation is set to "auto", direction that the device has selected is displayed.) <b>Forward:</b> Ascending <b>Reverse:</b> Descending
	Errors	Device errors
	Warning	Device warning
	Digital input	State of digital inputs
	Encoder	Optical encoder position (0 - 3999)
Manual control	START:	See above.
	STOP:	See above.
	C/W:	Valve switches between collect/waste.
	NEXT:	See above.
Advance button	Diagnostic...	Display the log and device report.
	Decode errors	Display errors text.
	Decode warning	Display warnings text.
	Stop error sound	Perform stop of error sound.

### 6.4.3. On-line Configuration of Detector

#### ON-LINE CONFIGURATION OF DETECTOR - DET

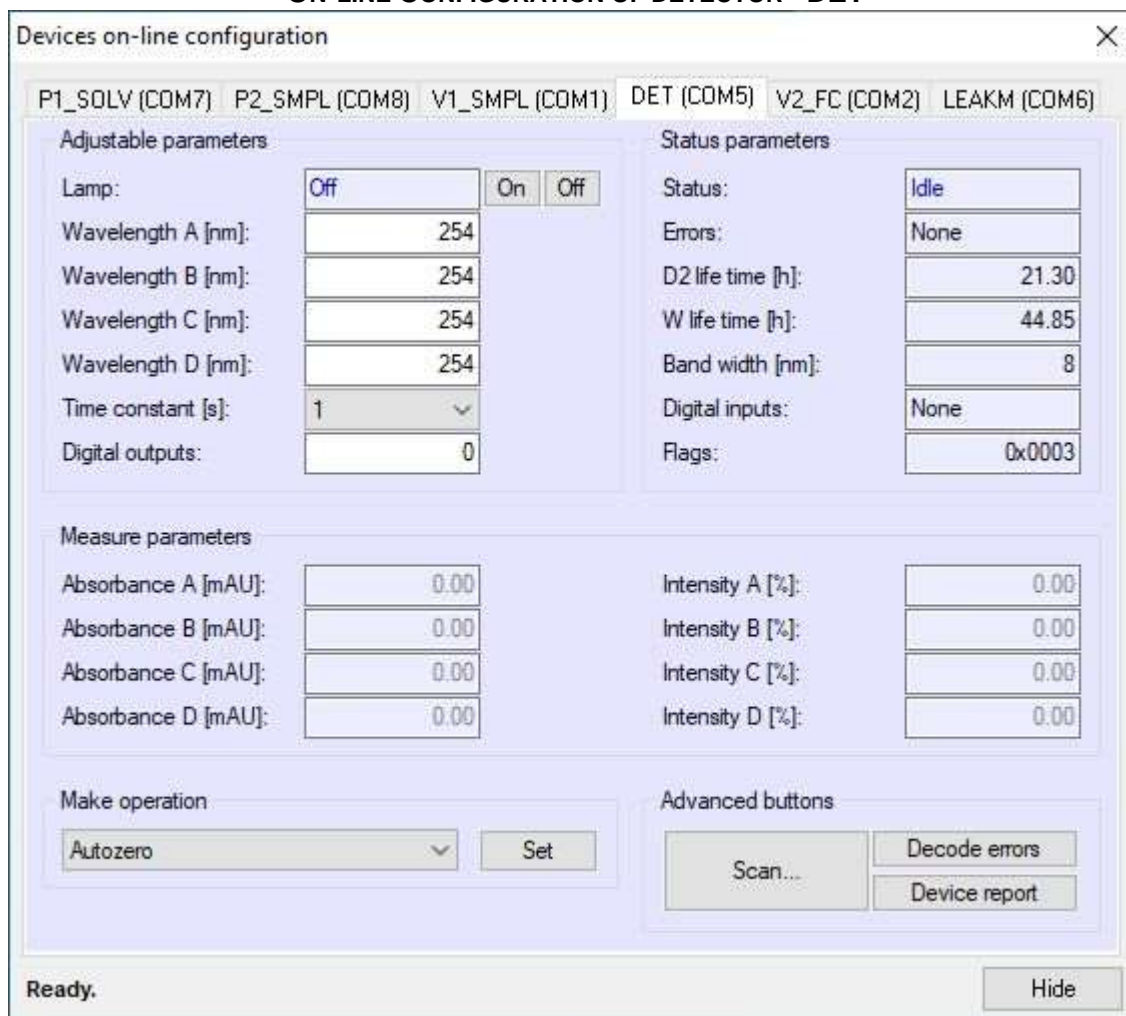

#### DESCRIPTION OF ITEMS

Group	Parameter	Description
Adjustable parameters	Lamp	Shows lamp state. Buttons <i>On/Off</i> starts and stops the lamp.
	Wavelength A-D [nm]	Setting the wavelengths.
	Time constant	see 6.2.2.
Status parameters	Status	<i>Idle</i> - default state. <i>Init lamp</i> - lamp initiation. <i>Meas. mode</i> - measuring mode. <i>Autozero</i> - automatic zeroing of signals.
	Error	Hexadecimal error code.
	D2/W Life time [h]	Deuterium/halogen lamp life time counter.
	Band width [nm]	see 6.2.2. Read only.
	Flag	Hexadecimal flags code (see communication protocol).
	Measure	Absorbance A-D [mV]

Group	Parameter	Description
parameters	Intensity A-D [%]	Light intensity. New lamp has set 100% with Test cell inserted.
Make operation	This operation is performed after a selection is made and pressing the button <i>Set</i> .	
	Autozero	Automatic zeroing of signals. Default value.
	Make a beep	Unit makes short beep by its internal speaker.
	Keep remote	Send keep remote command (diagnostic feature).
	Stop error sound	Turn off error signalization.
	Disable timeout	Send disable timeout command (diagnostic feature).
	Open shutter	Internal using of device.*
	Close shutter	Internal using of device.*
	Start shutter test	Internal using of device.*
	Stop shutter test	Internal using of device.*
	Reset detector	Reset of processor. <b>Do NOT use this.</b>
	Make a test	It is not supported.
Advanced buttons	Scan...	Show <i>Scanning...</i> windows.
	Decode errors	Show text of errors.
	Device report	Show info list of the unit.

*More information about options is in Manual-TOY18\_20DAD\_HK\_H*

*\* Open shutter, Close shutter, Start shutter test, Stop shutter test, Reset detector, Make a test are operations intended of internal service which DO NOT USE THIS!*

### 6.4.4. On-line Configuration of Fraction Collector

**Caution:** Do NOT use the fraction table to control sample collection and manual collection together during analysis.

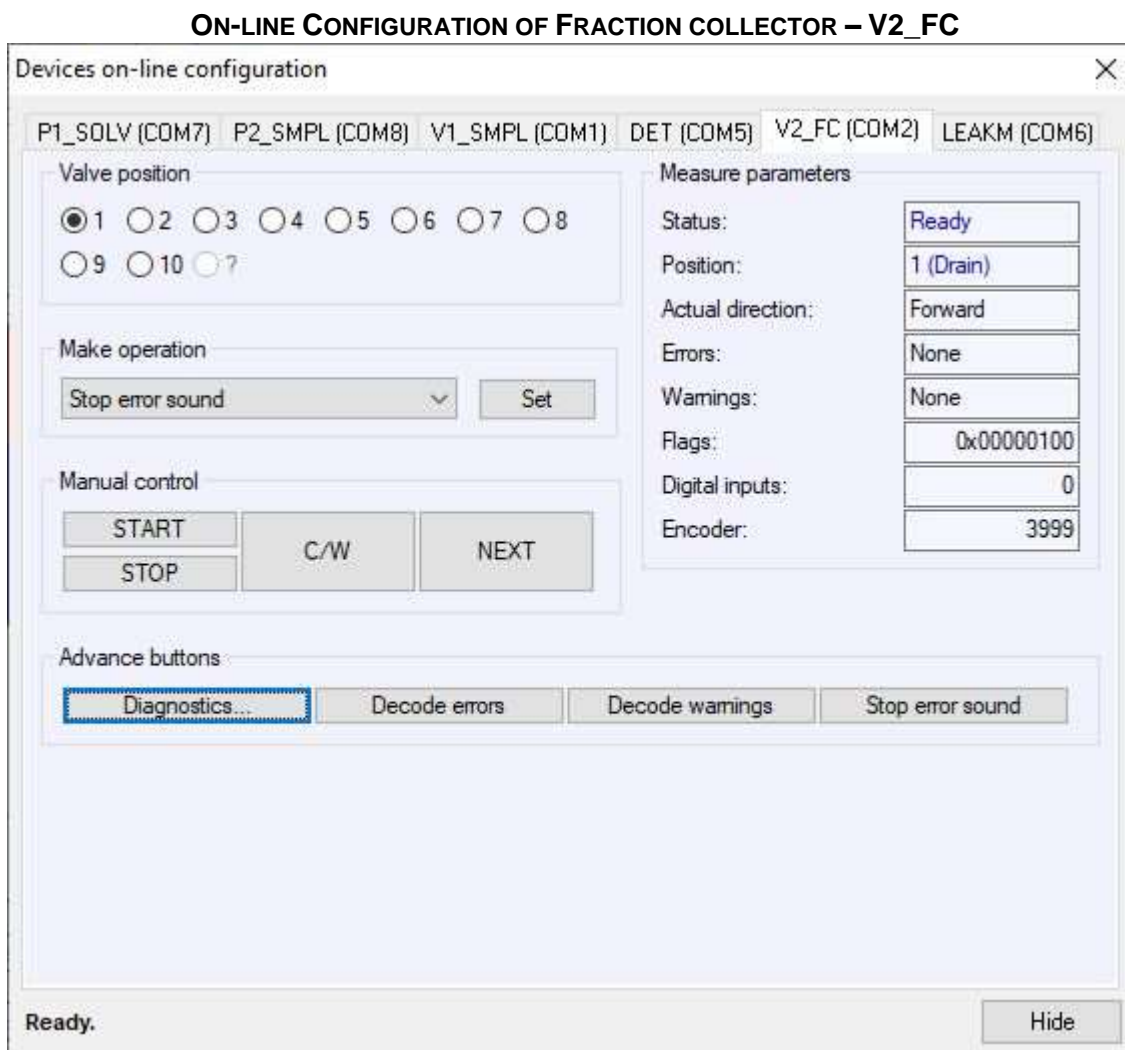

#### DESCRIPTION OF ITEM

Group	Parameter	Description
Valve position	1 - ?	Click on the field with the position number to turn the valve to that position. The question mark "?" indicates a closed position.
Make operation	This operation is performed after a selection is made and pressing the Set button.	
	Stop error sound	Stop error sound.
	Make a beep	Unit makes short beep by its internal speaker.
	Home position	Turn the valve to the home position.
	Increase position	Turn the valve to next higher position.

Group	Parameter	Description
	Decrease position	Turn the valve to next lower position.
	Toggle position	Change the position of the two-position valve.
	Close valve	Turn the valve to the closed position.
	Calibration	Perform calibration.
	Start	Valve is set to default position 1 (waste). Start of manual collection.
	Collects	Valve switched to collect.
	Waste	Valve switches to waste.
	Next	Valve rotated to next position (collect to next collect or waste to next waste).
	Stop	Valve is set to default position 1 (waste). Stop of manual collection.
	Make a test	It is not support.
Measure parameters	Status	Device state
	Position	Current valve position.
	Actual direction	Indicates direction of valve rotation. (If the rotation is set to "auto", direction that the device has selected is displayed.) <b>Forward:</b> Ascending <b>Reverse:</b> Descending
	Errors	Device errors
	Warning	Device warning
	Digital input	State of digital inputs
	Encoder	Optical encoder position (0 - 3999)
Manual control	START:	See above.
	STOP:	See above.
	C/W:	Valve switches between collect/waste position.
	NEXT:	See above.
Advance button	Diagnostic...	Display the log and device report.
	Decode errors	Display errors text.
	Decode warning	Display warnings text.
	Stop error sound	Perform stop of error sound.

### 6.4.5. On-line Configuration of ECLM2000 Leakage module

#### ON-LINE CONFIGURATION OF EXTERNAL LEAKAGE SENSOR - LEAKM

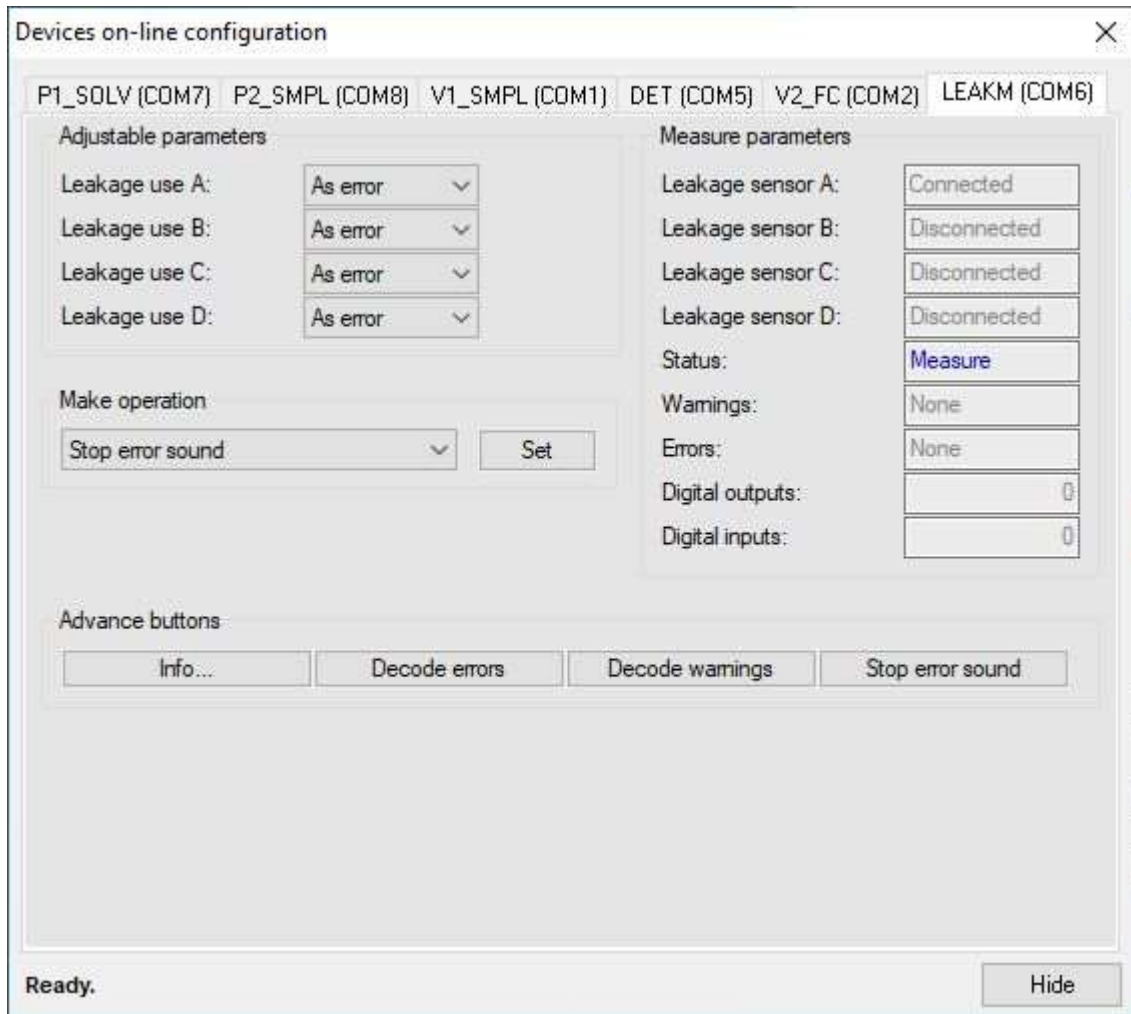

The screenshot shows a software window titled "Devices on-line configuration" for the "LEAKM (COM6)" device. It is divided into several sections:

- Adjustable parameters:** Four dropdown menus for "Leakage use A:", "Leakage use B:", "Leakage use C:", and "Leakage use D:", all currently set to "As error".
- Measure parameters:** Four dropdown menus for "Leakage sensor A:", "Leakage sensor B:", "Leakage sensor C:", and "Leakage sensor D:", with values "Connected", "Disconnected", "Disconnected", and "Disconnected" respectively. Other fields include "Status" (Measure), "Warnings" (None), "Errors" (None), "Digital outputs" (0), and "Digital inputs" (0).
- Make operation:** A dropdown menu set to "Stop error sound" and a "Set" button.
- Advance buttons:** Four buttons: "Info...", "Decode errors", "Decode warnings", and "Stop error sound".

At the bottom left, it says "Ready." and at the bottom right, there is a "Hide" button.

#### DESCRIPTION OF ITEM

Group	Parameter	Description
Adjustable parameters	Leakage use A-D	Choice of sensor reaction – as error or as warning.
Make operation	This operation is performed after a selection is made and pressing the <i>Set</i> button.	
	Stop error sound	Stop error sound.
	Make a beep	Unit makes short beep by its internal speaker.
	Make a test	It is not support.
Measure parameters	Leakage sensor A-D	Shows whether the sensor is connected or disconnect.
	Status	Device state.
	Warning	Device warning.
	Errors	Device errors.
	Digital output	State of digital outputs.

Group	Parameter	Description
	Digital input	State of digital inputs.
Advance button	Info...	Display the device info list.
	Decode errors	Display errors text.
	Decode warning	Display warnings text.
	Stop error sound	Perform stop of error sound.

## 6.5. Method Setting Configuration

Opening *Control...* is done by entering to *Method >Control...* from the main menu item or by clicking on the  icon from toolbar or after completing the *Devices...* dialog, by clicking the *Control* button in the Method settings dialog.

This item allows setting parameters in the time tables with various functions set, such as the gradient table, sample collection.

### 6.5.1. Time Table Configuration

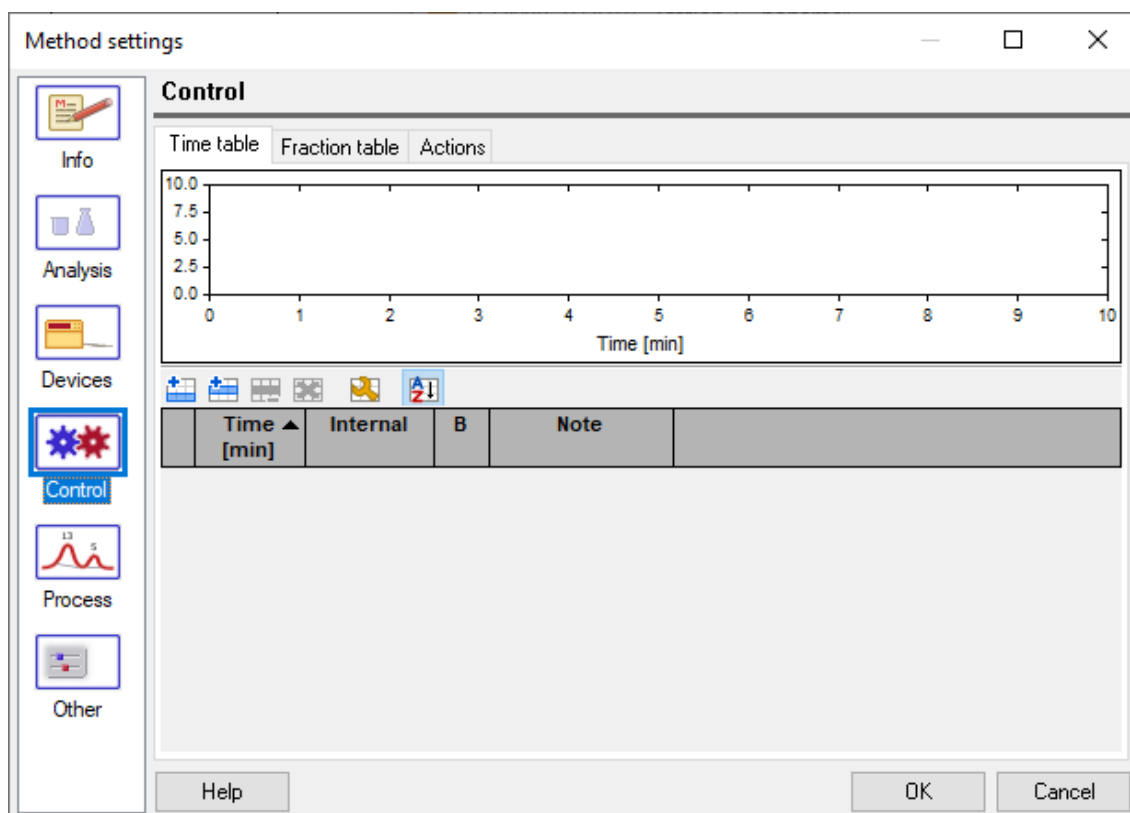

The default setting of the time table shows *Time, Internal, B, Note* column without any rows. The graph area shows progress of action at a specific time. There are set in the table. More information about configuration is in internal Help of Ecomac.

#### BASIC COLUMN DESCRIPTION

Column	Parameter	Description
Time [min]	Value of time	Time which a step begins at.



Column	Parameter	Description
Internal	Ext. mark	External mark is displayed in graph.
	Autozero	Autozero is performed.
	Beep	Sound signalization is performed.
	Test	Special operation for internal usage. <b>Do NOT use it!</b>
	Make EMF	Currently measuring data as .emf file is saved.
	Snapshot	Currently measuring data are saved. Data window is opened.
	Pause	Pause of analysis is performed.
	Stop	Analysis ends. Data window is opened. Data saving is depended on setting in <i>Analysis...</i> section of <i>Method setting</i> dialog.
	Quit	Stops analysis and deinitiates devices from application. Opens data window. Saves data depending on setting in the <i>Analysis...</i> section of <i>Method setting</i> dialog.
B	B/E	Cycle repeatability of several steps sequence.
Note	text	Field for a note.

### Time Table Column Configuration

The *Setup control properties* dialog is opened by clicking on the  icon. By clicking on OK button, setting and change in this dialog are confirmed and set function and their feature are displayed in the time table, the graph area and the dialog is closed. By clicking on Cancel button, the dialog is closed without saving settings.

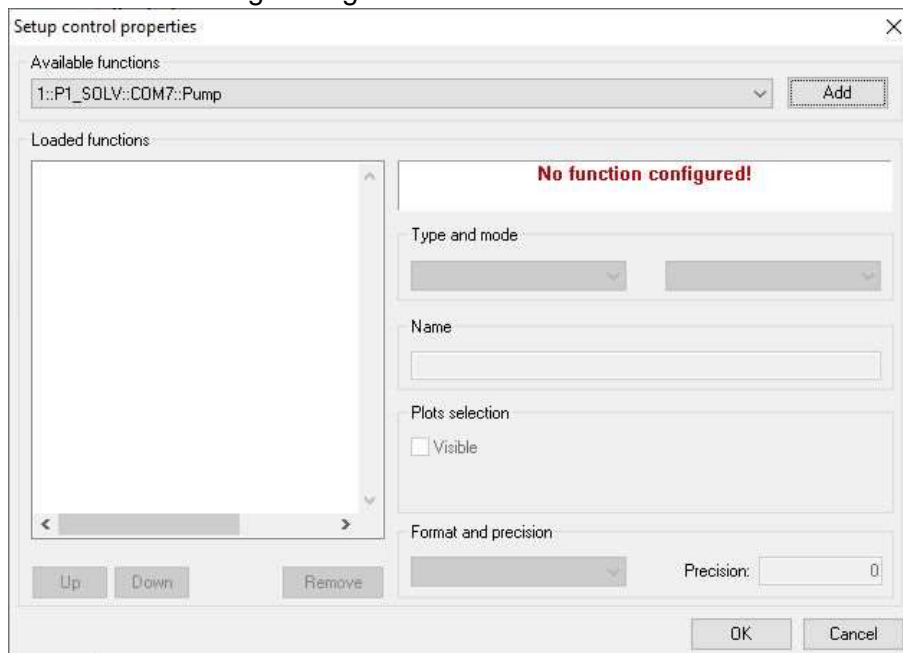

The functions of the time table columns are selected in the *Available functions* section. Each device connected to the unit has several options. Device functions are sorted according to

their loading order in the *Devices* section (device position number, device model, IP address or COM port, function name), see picture below. List items are depended on device type. Selected function is highlighted. By clicking on Add button, the function is added to the space on the left side in section *Loaded functions*.

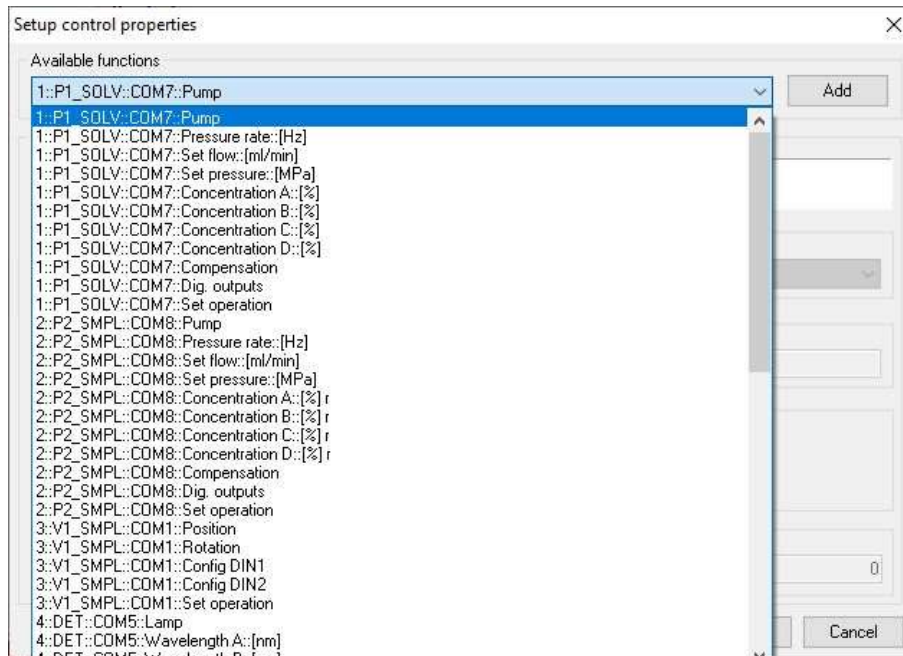

**Note:** If the device configuration is changed in the *Devices* section, then the No. order device function is changed too. So, this will affect the *Loaded function* section, and it will display *Function is invalid!!!*. To resolve this issue, the device function has to be loaded again, and then it displays *Function is valid!*

The order of individual items can be changed using the Up and Down buttons. To remove an item, click the Remove button. This order determines the order of columns in the time table.

The *Name* section is where a new function name can be written. It is displayed in the table.

The choice of plots is visible in the graph area (in the drawing and legends section) after initiation of a device (READY working mode). They are always visible in the OFFLINE working mode in the graph area.

**DESCRIPTION AVAILABLE FUNCTION FOR P1\_SOLV, P2\_SMPL**

Group	Parameter	Description
Pump	True / False	<b>True</b> - pump is pumping. <b>False</b> – pump is not pumping.
Pressure rate	[Hz]	Sample rate, see 6.2.1.
Set flow	[ml/min]	Set value of flow rate.
Set pressure	[MPa]	Set value of pressure.
Concentration A-D	[%]	Set concentration of each channel.
Compensation	Off, Learned 0 (tmp), Learned 1 (mem)	Set compensation learning mode, see 6.2.1.
Dig. outputs	ACO open, ACO close	This unit is not supported.

Group	Parameter	Description
Set operation	Stop error sound	These operations are the same as <i>Make operation</i> in <i>Device on-line configuration</i> dialog, see 6.4.1.
	Start comp. learning	
	Stop comp. learning	
	Abort comp. learning	
	Enable purge mode	
	Disable purge mode	
	Clear FIFO	
	Close valves	
	Quit program	
	Valves by conc.	
	Test valves	

DESCRIPTION AVAILABLE FUNCTION FOR V1\_SMPL

Group	Parameter	Description
Position	V1_SMPL 1-2	Number of positions, see 6.2.2.
Rotation	Auto, Clockwise	Rotation mode, see 6.2.2, 6.2.4.
Config DIN1, DIN2	-	It is not supported.
Set operation	Stop error sound and more	Items are the same as <i>Make operation items</i> in the chapter 6.4.4.

DESCRIPTION AVAILABLE FUNCTION FOR DET

Group	Parameter	Description
Lamp	True / False	<b>True</b> – lamp is switched on, <b>False</b> – lamp is switched off.
Wavelength A-D	[nm]	Set value of wavelength.
Time constant	[s]	Set time constant value, see 6.2.3, 6.4.3.
Sample rate	[Hz]	Set sample rate, see 6.2.3.
Digital outputs	0, 1	Not supported.
D-multiplier	Value	Multiplier of D channel value.
D-function	Math function for channel A, B	See 6.2.3.
Negative range	Normal, Medium, High	Set negative range mode, see 6.2.3.
Thresholds S1, S2	[mAU]	Set of thresholds value.
D-offset	Value	Offset of D channel.
Set operation	Autozero and more	Items are the same as <i>Make operation items</i> in the chapter 6.4.3.

### 6.5.2. Fraction Table Configuration

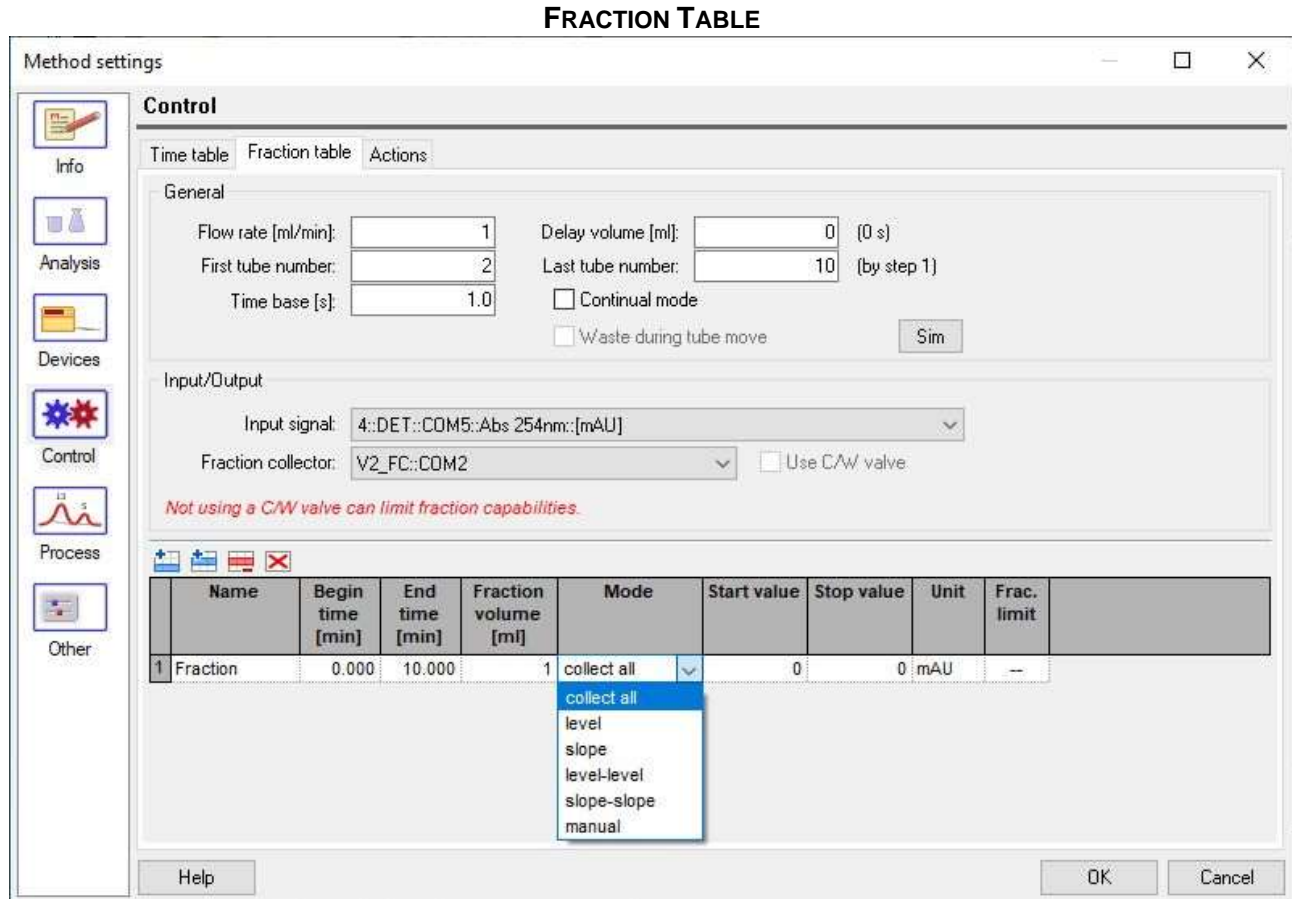

Fraction table configuration is described in internal Help of Ecomac.

#### FRACTION COLLECTOR PARAMETERS

Column	Parameter	Description
General	Flow rate [ml/min]	Flow rate is set for fraction process to determine actual collection volume in conjunction with Fraction volume from fraction table. This can avoid overflowing of a tube. The values must correspond to the pump flow rate set in this method.
	Delay volume [ml]	Dead volume in tubes between detector and fraction collector is set. It takes into consideration flow rate and delay time is shown behind field in parentheses (see 13).
	First tube number	Starting tube of fraction process. The first tube value can be restricted on specific fraction collector. <b>The first tube number is always 2 for this valve type in the unit.</b>

Column	Parameter	Description
	Last tube number	Stopping tube of fraction process. The last tube value can be restricted on specific fraction collector. <b>Text in brackets behind item <i>Last tube number</i> is changed by step 1 or by step 2. It is depended on the setting in <i>Positions step</i> (see 6.4.4).</b>
	Time base [s]	Time base is set for which a change of signal (slope) is calculated. This value should correspond to character of signal (speed of changes, noise, etc.) to eliminate detection problems. Lower value makes quick response, higher value filters signal more effectively. For more understanding see collecting modes.
	Continual mode	It enables single collection process through multiple analyses
	Waste during tube move	It is not support for this valve type in the unit.
	Sim	It opens dialog where can be recorded simulation data and can be performed simulation of fraction process by pressing button.
Input/Output	Input signal	A measured signal is set (e.g. from detector), according which collecting process can work with. Only one signal is possible to select from list of available signals in combobox. List of signals depends on currently configured devices. The fraction table can be used without signal, but some features will be ignored
	Fraction collector	A fraction collector is set for fraction process. Only one fraction collector is possible to select from list of available fraction collectors. List of fraction collectors depends on currently configured. Fraction table will not work without a fraction collector, but you can use a virtual FC.
	Use C/W valve	It enables using COLLECT/WASTE valve during collecting process. The C/W valve can stop collecting of fractions at any time and it is recommended to use it. But some fraction collectors do not have this valve and fraction features are enough limited (when collection starts, it can not be paused, so it runs until last vial or time is reached; fraction limits can not be used).

### 6.5.3. Example Method

The example method is saved as PREPBOX\_A3L8E\_example-01.mxl in C:\ECOMAC\methods.

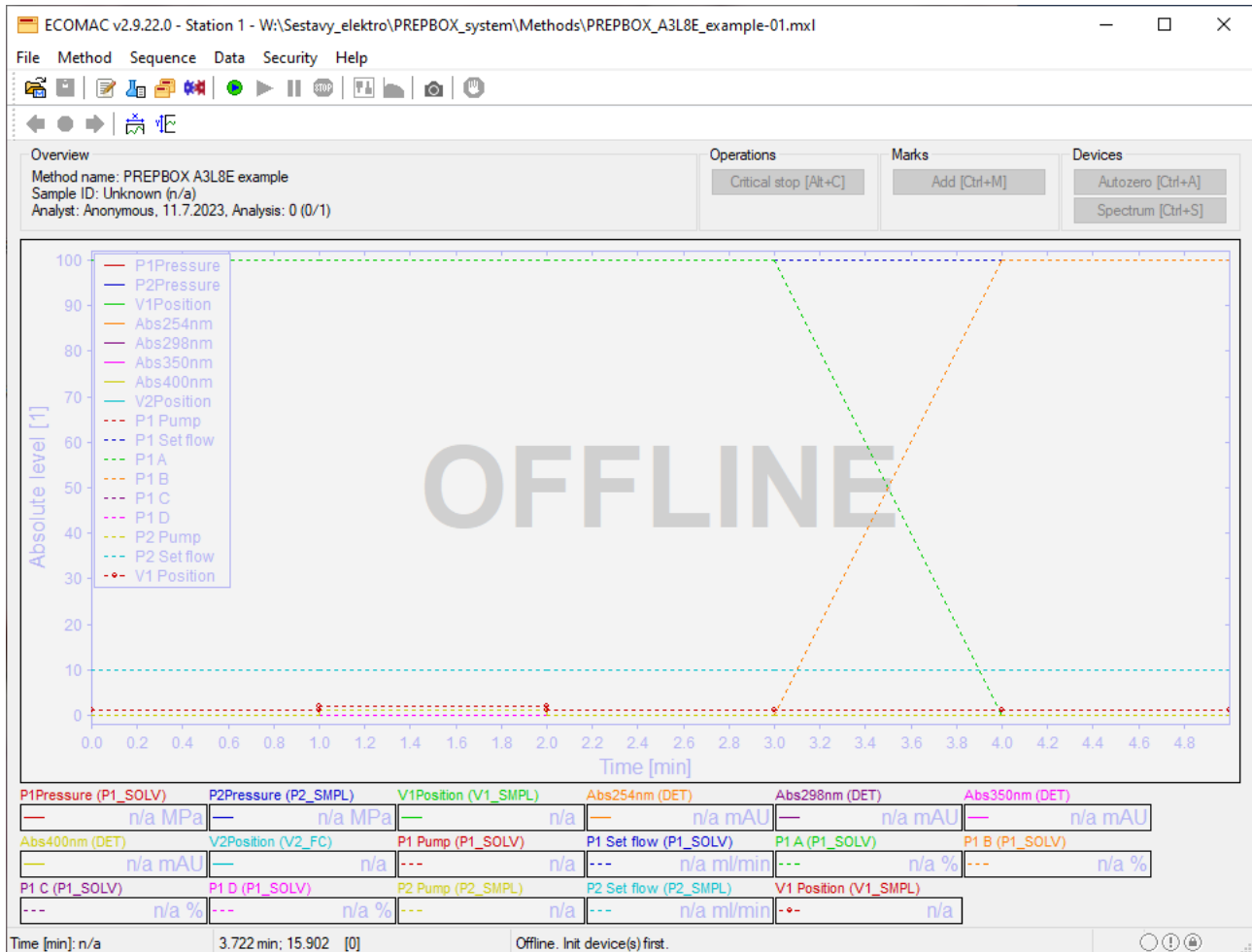

Here, all the necessary measured signals are set up for recording during analysis, which are very useful for solving analysis problems later. The example time table setting for this example analysis and an input signal (the one channel signal from the detector DET) and an output signal (the signal for fraction collector V2\_FC) for collection is prepared.

- Example:** Dosing of 10 ml sample by P2\_SMPL pump, see below. The columns of the time table are added from *Setup control properties* dialog:
- P1\_SOLV P1 Pump (pumping/not pumping), P1 Set flow (flow rate ml/min), P1 A-D (concentration %).
  - P2\_SMPL P2 Pump (pumping/not pumping), P2 Set flow (flow rate ml/min).
- When the sample is dosing by P2\_SMPL pump so P1\_SOLV pump must be stopped. See in P1 Pump and P2 Pump column, steps 3 and 4.**
- V1\_SMPL V1 Position (see 6.2.2).

After 1 min, autozero is performed and external marks are added at starting and finished of sample dosing, see *Internal* column.

### TIME TABLE

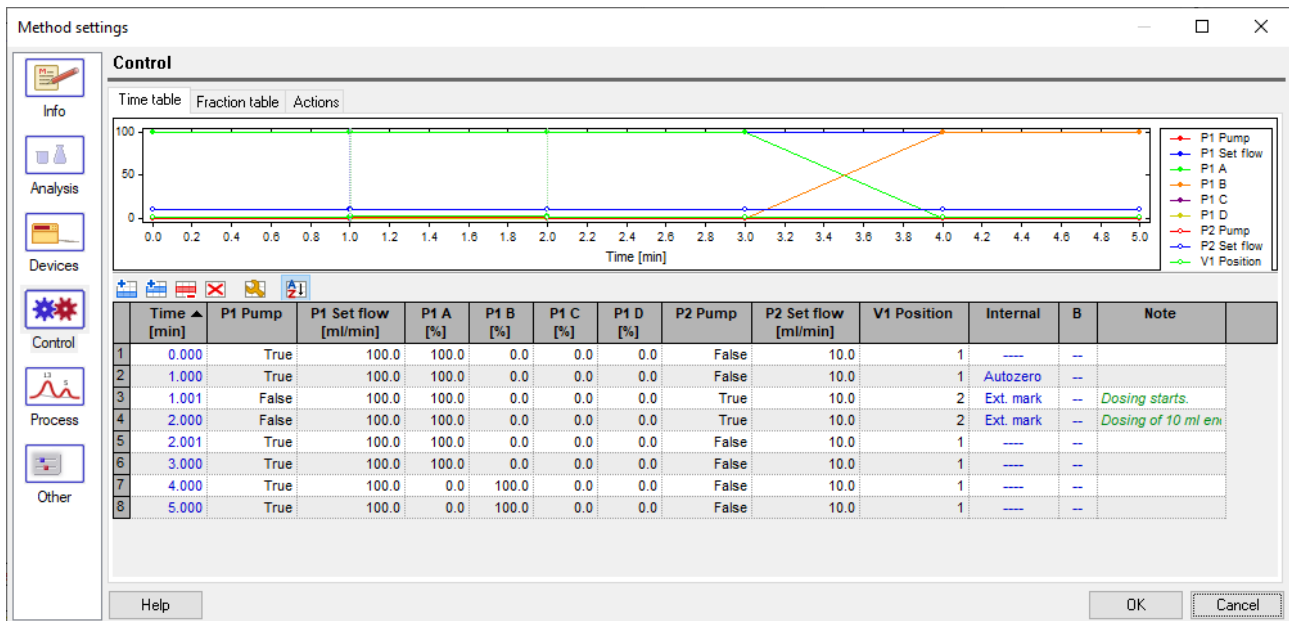

## 6.6. Running and Stopping of Analysis

Press the  button first and insert the analysis properties as is described in internal help.

Press the  button to start manual analysis. This starts recording of analysis. Modification of devices parameters is not allowed during running analysis.

Press the  button to stop current analysis. New window with measured data is opened. You can save this data by the menu *File > Save as*.

## 6.7. Deinitiation of Communication with Unit

Save the measured data and method changes before deinitiation of communication.

Press the  button to deinitiate communication with unit. Next, the application can be closed.

## 7. SERVICE

**Caution:** The unit must be disconnected from the power supply before servicing!!!

### 7.1. Replacement of Line Fuse



Use a flathead screwdriver to release the fuse holder from its base.

Take out the fuse holder.



Remove the old-line fuse.

Insert a new line fuse in the holder as **noted on the product label**. This is part of the detector accessories.



Insert the fuse holder back in.

Push the fuse holder all the way inside.

## 7.2. Parts Replacement

In the following chapters, the replacement process of parts – seals (in working head and washing head), check valves, deuterium lamp (D2), halogen (tungsten) lamp (W) - is described.

Other replaceable parts are the needle and the O-ring in the degassing/purging valve. This exchange is not recorded by the device.

**Caution:** Before and after parts replacement, save Info sheet from ECOMAC.  
**Caution:** New seals should be rinsed in isopropanol or methanol before replacement. Eventually clean them using an ultrasonic bath.

### 7.2.1. Pump 300 ml/min Seals

**Caution:** The pump piston is made of fragile material. When mishandled, its smooth surface may be irreversibly damaged or it may crack!



**Disconnect the unit from power source!!!**  
 Disconnect inlet tubing.

Loosen nut on head using a 3/8" and 10 side wrench from the unit accessories.  
 Slightly loosen the nut using the 3/8" side wrench in the inlet part.



Dismount input and output capillary.

Loosen screws in the head using TX20 screwdriver from the unit accessories.





Pull the head straightly out of the piston.  
**Sliding the head along the sides may cause piston damage!**  
Detail of working head.  
The seal can stay on piston or in the head.



Remove the seal using a suitable tool. Wash and clean the piston and interior of the head with isopropanol.  
**Be careful when removing the seal from the piston.**



Usually, it is not necessary to exchange the seal in the washing heads. But in case it is necessary, follow the same steps as with the working heads.

---

**Note:** Wet new seal in isopropanol and place it on the piston carefully. The spring must face towards the head.

---

Reverse the disassembly steps provided above to reassemble the unit.

Carefully push the head with the new seal back straight onto the piston. **Sliding the head along the sides may cause seal damage.**

---

**Caution:** Alternately, screw in the left and right screw into the heads of each block. Each screw must be screwed with the same number of turns.

---

**New seals should be run in before the first use.** Disconnect all equipment connected to the pump output. Connect the reduction valve (or other reliable hydrodynamic resistor) directly to the pump output. Put the inlet tubing and output capillary into same reservoir with solvent isopropanol: water at a 1:1 ratio.

---

**Note:** Using 10 µm filter before the reduction valve is recommended. Small pieces of the seal are sometimes released.

---

Set the flow rate to 300 ml/min, start pumping and set pressure to 2MPa using reduction valve. Let the pump run for at least 30 min (optimally 2 h). Keep the flow rate at 300 ml/min and set pressure to 5 MPa. Let the pump run for at least 30 min (optimally 2h). Keep the flow rate at 300 ml/min and set pressure to 10 MPa. Let the pump run for at least 10 min (optimally 30 min.). Then set flow rate at 30 ml/min and pressure to 2 MPa. Let the pump run for at least 10 min (optimally 30 min).

The seals are now set and run-in. The pump is ready for standard operation. Do not forget to wash the isopropanol from the pump using your mobile phase. (If the pressure decreases during operation, you must run the pump in for a longer time [optimally]. If you do not have a reduction valve, you can use an old column, which meets the above stated parameters).

**Caution:** Watch the washing heads and all connections during the run-in for any leakage. Correct every loose fitting!

### 7.2.2. Pump 1000 ml/min Seals

**Caution:** The pump piston is made of fragile material. When mishandled, its smooth surface may be irreversibly damaged or it may crack!



**Disconnect the unit from its power source!!!**

Disconnect inlet tubing.  
Using the 3/8" side wrench, slightly loosen the nut in the degassing valve.

Using the 12 mm and 3/8" side wrench from the unit accessories, loosen the nuts on the head.



Using the TX20 screwdriver from the unit accessories, loosen the screws in the head from both blocks.

Pull the head straightly out of the piston.

**Sliding the head along the sides may cause piston damage!**



Using a suitable tool (eg a thin knife or a thin flathead), remove the seal. Wash and clean the piston and interior of the head with isopropanol.

**Be careful when removing the seal from the piston.**



Pull the head straightly out of the piston.

**Sliding the head along the sides may cause piston damage!**

The seal can stay on the piston.  
**Be careful when removing the seal from the piston.**



Usually, it is not necessary to exchange the seal in washing heads. But in case it is needed, follow the same steps as with working heads.



Pull out the sealing ring.

---

**Note:** Wet the new seal in isopropanol and place it on the piston carefully. The spring is facing toward the head.

---

Reverse the disassembly steps provided above to reassemble the unit.

Push the head with the new seal straight back onto the piston. **Sliding the head along the sides may cause seal damage.**

---

**Caution:** Alternately screw in the left and right screws into the heads of each block. Each screw must be screwed with the same number of turns.

---

**New seals should be run in before the first use.** Disconnect all equipment connected to the pump output. Connect the reduction valve (or other reliable hydrodynamic resistor) directly to the pump output. Put the inlet tubing and output capillary into same reservoir with solvent isopropanol: water at a ratio of 1:1.

---

**Note:** Using 10  $\mu\text{m}$  filter before the reduction valve is recommended. Small pieces of seal are sometimes released.

---

Set the flow rate to 1000 ml/min, start pumping and set pressure to 5 MPa using the reduction valve. Let the pump run for at least 30 min (optimally 2 h). Keep the flow rate at 1000 ml/min and set pressure to 10 MPa. Let the pump run for at least 30 min (optimally 2h). Keep the flow rate at 1000 ml/min and set pressure to 14 MPa. Let the pump run for at least 10 min (optimally 30 min.). Then set flow rate at 100 ml/min and pressure to 7.5 MPa. Let the pump run for at least 10 min (optimally 1 h).

The seals are now set and run-in. The pump is ready for standard operation. Do not forget to wash the isopropanol from the pump using your mobile phase. (If the pressure decreases during operation, you must run the pump in for a longer time [optimally]. If you do not have a reduction valve, you can use an old column, which meets the above stated parameters).

---

**Caution:** Watch the washing heads and all connections during the run-in for any leakage. Correct every loose fitting!

---

### 7.2.3. Pump 300 ml/min Check Valves



The basis of the check valve is a precise **ball and seat** placed in a case made of PEEK with stainless steel reinforcement. Liquid flow pushes the ball (ceramics) into the seat (ceramics) and this way it seals. With regard to high pressures in the pump any **slight impurity** stuck on the ball or seat may cause **pressure fluctuation** or the pump cannot start at all. If it is not possible to eliminate this problem by repeated purges, you must exchange or clean the check valves.

Flow direction through the valve is indicated by the groove on the check valve housing.



**Disconnect the unit from power source!!!**

Disconnect the inlet tubing. Using the 3/8" and 10 mm side wrench from the unit accessories, loosen the nut on the head. Using the 3/8" side wrench, slightly loosen the nut in the inlet part.

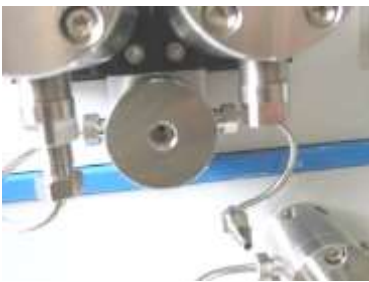

Dismount inlet capillary.

Using the 10 mm side wrench, loosen the inlet check valve. Remove the holder with the inlet valve.



Take out inlet valve from the holder. Replace the inlet valve with a new one.

**The ring around valve body has to be facing up!!!**



Using the 3/8" side wrench, slightly loosen the nut in the degassing valve. Using the 3/8" and 10 mm side wrench, loosen the capillary on the outlet valve holder and bend it slightly.



Using the 10 mm side wrench, loosen its holder. Exchange the outlet valve.

**The ring around valve body has to be facing up!!!**

Insert the new valve in the same way as the old one, i.e., the groove must be oriented so the head faces up. Reverse the disassembly steps provided above to reassemble the unit. Strongly tighten all screws. After starting the pump, check all connections for any leakage.

**Caution: After replacing check valves, purge/degas the unit.**

#### 7.2.4. Pump 1000 ml/min Check Valves



The basis of check valve is a precise **ball and seat** placed in a case made of PEEK with stainless steel reinforcement. Liquid flow pushes the ball (ruby) into the seat (ceramics) and this way it seals. With regard to high pressures in the pump any **slight impurity** stuck on the ball or seat may cause **pressure fluctuation** or the pump cannot start at all. If it is not possible to eliminate this problem by repeated purges, you must exchange or clean the check valves.

Flow direction through the valve is indicated by the groove on the check valve housing.



**Disconnect the unit from its power source!!!**

Disconnect inlet tubing into degassing/purging valve. Using the 3/8" side wrench, slightly loosen the nut in the degassing valve.

Using the 12 mm and 3/8" side wrench from the unit accessories, loosen the nuts on the head.



Dismount the outlet capillary.

Using the 12 mm side wrench, loosen its holder. Exchange the outlet valve.

**The ring around valve body has to be facing up!!!**

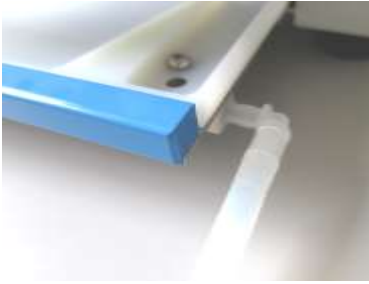

Dismount the waste silicon tubing with the connector.  
Using the TX20 screwdriver, loosen the screw in the bath, which holds the bath and the waste drain.



The waste drain with the o-ring seal, nut, and washer are now accessible.  
**Very carefully pull out the plastic bath. Be careful of the leakage sensors.**



There is a hole under the pumping blocks.  
Using the TX20 screwdriver, loosen screws in the prism which holds both heads.  
Evenly loosen all the screws.

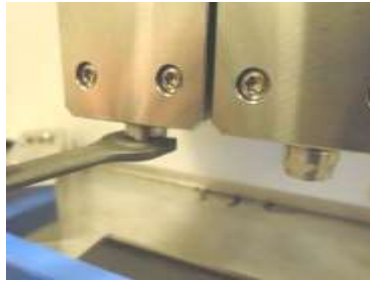

The inlet check valves are at the bottom of the heads.  
Using the 12 mm side wrench, loosen the holder and take it out.



Exchange the inlet valve.  
**The ring around valve body has to be facing up!!!**

Insert the new valve in the same way as the old one, i.e. the groove must be oriented head up. Reverse the disassembly steps provided above to reassemble the unit. Strongly tighten all screws. After starting the pump, check all connections for any leakage.

**Caution:** Alternately screw the left and right screws at the opposite corners into the prism which hold both head.  
**Caution:** After replacing the check valves, purge/degas the unit.

### 7.2.5. Pump 300 ml/min and 1000 ml/min Needle of Degassing/Purging Valve

Construction of the degassing/purging valve is the same for pump 300 ml/min and 1000 ml/min. The body of valve is in front of unit and it is connection with pressure sensor which is inside of unit.



**Disconnect the unit from its power source!!!**

Unscrew the needle.

Screw in the new needle.

### 7.2.6. Pump 300 ml/min and 1000 ml/min O-ring and Seal in Degassing/Purging Valve

Construction of degassing/purging valve is the same for the pump 300 ml/min and 1000 ml/min. The body of the valve is in the front of the unit, and it provides the connection with the pressure sensor which is inside of the unit.



Using the TX20 screwdriver from the unit accessories, unscrew the two screws.

Take out the head of the degassing/purging valve. A transparent seal is under the head.



Unscrew the needle, take out the metal ring and the O-ring.

Put in the new O-ring.



Usually, the seal does not need to be exchanged.

In case it does, take out the seal and exchange it.

After replacing of the O-ring or seal, reverse the disassembly steps provided above to reassemble the unit.

**Caution:** Screw in the needle into the head of the degassing/purging valve in a way so that it does not go out of the valve. Next, screw in the head of the valve with the needle onto the pressure sensor.

### 7.2.7. Pistons

Replacement of a piston can be done only by a qualified person

### 7.2.8. Deuterium Lamp (D2)

The detector has many testing and adjusting functions. It can be controlled by Ecom FLASHH06Srv testing software (Window OS based). This can be download from the Ecom website.

**Caution:** The following operation must only be performed by a qualified person.

**Note:** A service manual for testing and adjusting the detector in FLASH06Srv is available upon request.

**UV light is dangerous for eyes.** During regular operation of the detector with unit cover installed, is UV light perfectly shielded. In case of any service or repair, when it is necessary to remove any parts covering the optical unit and the lamp is on, it is very important to protect your eyes with glasses absorbing UVA/UVB/UVC light.



**Prior to the below described procedures, disconnect the unit from power supply.**  
**The unit may be reconnected to the power supply only when the lamp is properly installed in its socket.**



**Disconnect the unit from the power source!!!**

Using the TX20 screwdriver from the unit accessories, loosen the screws in the metal grid and remove the cover.



Disconnect the connectors from the compartment under the lamp socket. Pass the front of the connector into the front of the unit.

Using the TX20 screwdriver, loosen the screws.





Carefully remove the lamp from the lamp socket.

**Never touch the quartz bulb of the lamp** with bare fingers, because fingerprints will irreversibly damage the lamp.

The construction of the lamp case allows only one correct position, so it is impossible to insert the lamp incorrectly. Insert the lamp along the groove on the lamp case.

After inserting the new lamp, reverse the disassembly steps provided above to reassemble the unit.

**Caution:** The groove on the connector of the supplied deuterium lamp cable must slide into the groove on the inside of the unit.

After replacing the deuterium lamp, the operating hours counter is reset, and after the new lamp burns, the intensity calibration is performed. **Only an authorized person can perform this process.** In the FLASH06Srv service SW, select the *New D2/TG lamp* test is selected and follow the procedure given below.

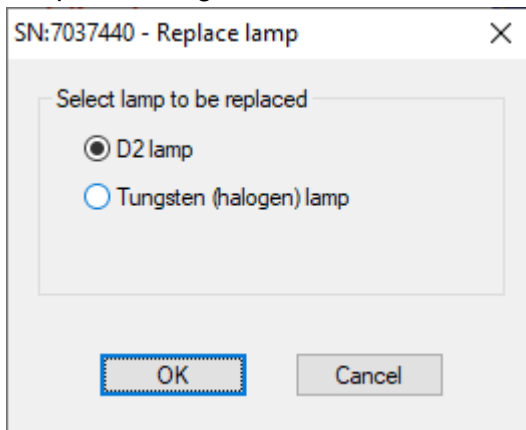

Connect the unit to the PC. Switch on the power supply and run the *New D2/TG lamp* process. Select *D2 lamp* in FLASH06Srv and push OK.

Warning



This operation erase lamp life time counter and increase number of lamps used in the unit.

- 1) Read unit manual first!!!
- 2) Exchange the lamp.
- 3) Press "OK" if you are sure.



The operating hours counter is set to zero and lamp number increases. (The working hours of all used lamps are displayed in the unit memory.)

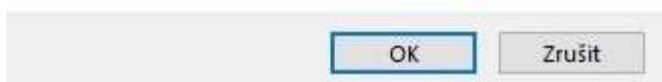

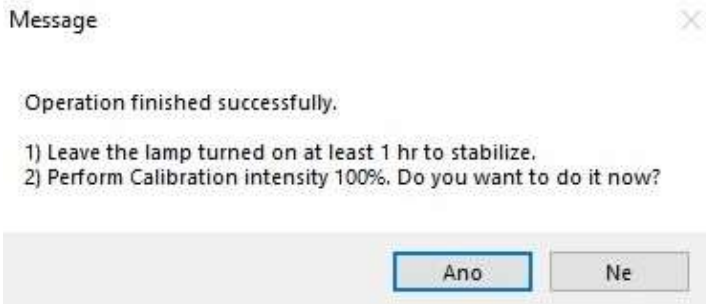

The intensity calibration has to be performed (which is described below). Click YES.

Lamp must be stabilized for 1 hour before intensity calibration.

### 7.2.9. Halogen (Tungsten) Lamp (W)



Disconnect the connectors of halogen lamp located on cable starting under unit cover.



Using the 5.5 mm side wrench from the unit accessories, release the screw on the halogen lamp holder.

It isn't necessary to remove the screw from the lamp holder. The pad is under the screw.

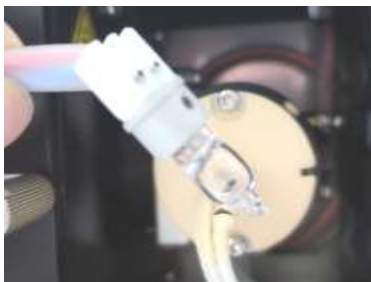

Remove the lamp and insert a new one.

**Never touch the quartz bulb with bare fingers**, because fingerprints will irreversibly damage the lamp after being switched on.

The construction of the lamp case allows only one correct position, so it is impossible to insert the lamp incorrectly. Insert the lamp along the groove on the lamp case.

After inserting the new lamp, reverse the disassembly steps provided above to reassemble the unit.

---

**Note:** If the screw with the pad is unscrewed from the lamp holder so it is outside the unit, the screw with the pad is screwed into the new one and then it is inserted inside.

---

**Caution:** The groove on the connector of the supplied halogen lamp cable must slide into the small groove on the inside of the unit.

We recommend replacing the halogen lamp and the deuterium lamp at the same time. If the lamps are replaced together, replace both lamps first. Then perform calibration process as described in the previous chapter.

**Caution:** If the halogen lamp is replaced separately, do not perform the intensity calibration.

After replacing the halogen lamp, the operating hours counter is reset, the check of the intensity scan is performed. **Only an authorized person can perform this process.** In the FLASH06Srv service SW, select the New D2/TG lamp test and follow the procedure given below.

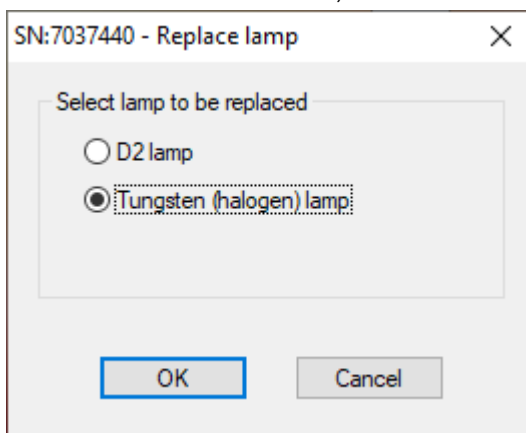

Connect the unit to the PC. Switch on the power supply and run *New D2/TG lamp* process. Select *Tungsten (halogen) lamp* in FLASH06Srv and push OK.

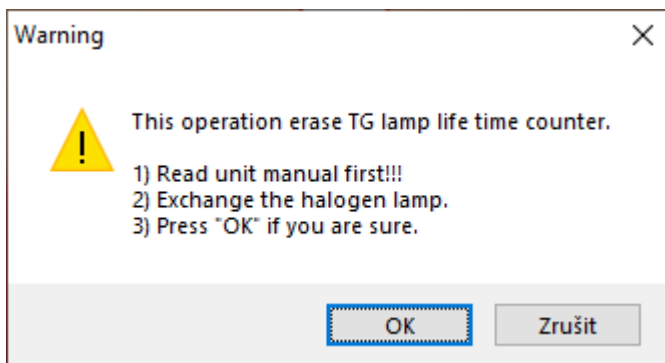

The operating hours counter is set to zero and lamp number increases.

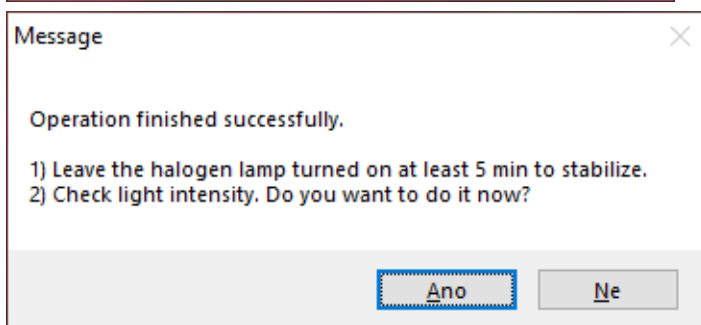

Perform a check of the intensity scan by clicking on YES.

Lamp must be stabilized for 5 min before checking the intensity of light.

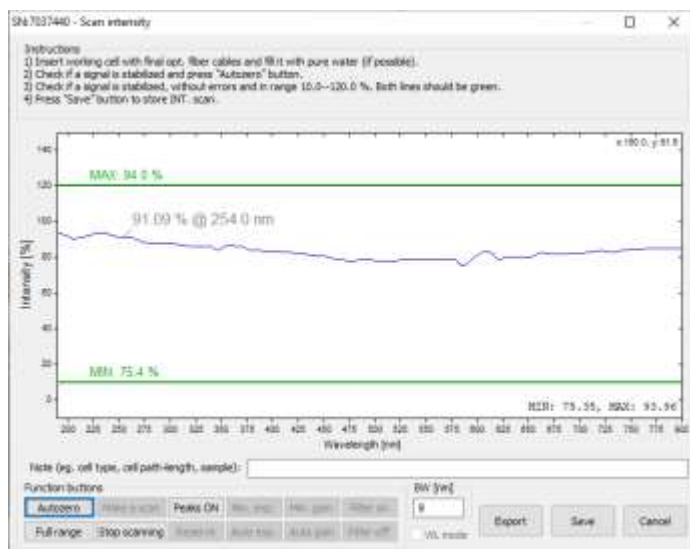

Follow the instructions in the dialog.

## 8. TROUBLESHOOTING

Problem	Caused by / Conditions	Solution
Leaking liquid from washing heads.	Damaged seal in pumping head.	Replace the seal immediately. The pump must not be used with damaged seal.
Pressure pulsation. Pressure sometime suddenly decreases.	Column, injection valve or other equipment connected after the pump is cause of problem.	Test if the problem persists without any equipment connected after the pump. Then try to connect any reliable source of hydrodynamic resistance (column, reduction valve).
	Bubbles.	Check all connections on capillaries and tubing before, in and after the pump. Try to purge the pump again and watch tubing after connection with the mobile phase filter for bubble formation. If any bubbles are formed there, exchange/rinse this filter. You can use the degassing unit.
	Bad check valve.	Try replacing the check valve (see 7.2.3, 7.2.4).
	Impurity in check valve.	Purge it with air flow or insert in ultrasound bath.

Problem	Caused by / Conditions	Solution
	Damaged seal – esp. when using solvents, such as Acetonitrile. It may seem like those bubbles are formed inside the pumping system. It is useful to exclude other sources of bubbles using a degasser.	Try to replace seals (see 7.2.1, 7.2.2).
	The pump is not run-in properly after seals replacement.	Run-in the pump under optimal conditions (see 7.2.1, 7.2.2).
	Electronic failure.	Contact service center.
Flowrate is lower than set value.	Pressure stability.	Problems with lower flow rate occur and usually relate to problems with pressure stability – see solution above.
	Solution agent.	Solution agents with very high or very low viscosity may cause these problems. Solvents which have not been degassed may cause these problems.
	Electronic failure.	Contact service center.
Motor works hardly/loudly, there isn't indicated any pressure and flow rate is low or none.	Clogged frit of outlet valve. Only an issue if check valves with frit are used.	Check the frit, try to clean it or replace the check valve.
	Electronic/mechanic failure.	Contact service center.
Higher noise and drift	Leaking cell, dirty cell, gas bubbles, nontransparent mobile phase, old/defective lamp, flow and temperature fluctuations.	Perform <i>Lamp test and Cell test</i> . Check cell connection. Check mobile phase. Check cell purity manually. Check pump. Stabilize the external environment. Heat the lamp sufficiently.
	Electronic / optic failure	Contact service center.
Leaking cell	Broken cell window, Defective seal.	Contact service center.
Valve doesn't switch.	Setting of method is set incorrectly in Ecomac.	Control setting in Ecomac.
	Electronic failure.	Contact service center.

\* Increasing noise and drift worsens the identification and reading of the analyte peak height. This affects the limit of detection value (LOD) and the limit of quantitation value (LOQ).

LOD is the lowest identifiable amount of analyte that produces a response of  $S = 3 * N$  ( $S...$  peak height;  $N...$  noise).

LOQ is the lowest quantifiable amount of analyte that elicits a  $S = 10 * N$  response.

## 9. MAINTENANCE

### 9.1. Period

The check valve and seals should be exchanged at least once a year. This period may be shorter if buffers, high pressure/flow rate, aggressive solvents, or other aggravating conditions are encountered. In case of such a difficult environment, we recommend exchanging the check valves and seals every 6 months.

Piston replacement can be done approximately once every 5 years when conditions are hard (or when pistons are damaged after the inappropriate replacement of other parts). When the unit is used under common conditions, replacement is done approximately once every 10 years.

The screw tightness of the pumping blocks (both working and washing types) should be checked once per month.

Check lubrication of the mechanical pump parts once per year.

Replace the mobile phase filters on the inlet tubing once per year.

Under heavy-duty operating conditions, check unit function (Operational qualification OQ, unit validation) once every 6 months. Under optimal conditions, check it once per year (or minimally once every 2 years). During unit validation, conduct a complete unit check. Depending on the observed unit condition, damaged parts can be replaced as needed.

### 9.2. Cleaning and Decontamination

Follow the safety instructions of agents used in chromatography process.

Use a dry or moistened cotton cloth for cleaning or the unit surface.

If the cell space is contaminated by liquid from the chromatography process, then first read the safety instructions for the liquid used and dry the space according to the safety instructions for that liquid. **Switch the lamp off before handling the cell.** Do not touch the cell windows or lens with fingers or any sharp or hard tools. (This is to protect the delicate surfaces of the optical parts.)

### 9.3. Storage and Transport

If the unit will be out of service for a longer period of time or it will be transported, it is advisable to purge it with isopropanol and plug it afterwards. Remove the unit door before transporting it and pack it to avoid damage during transportation.

### 9.4. Checking Tubing

Check all tubing connections for leaks before starting the process. Any liquid leaks must be removed.

### 9.5. Cleaning Check Valves

Remove the check valves (see 7.2.3, 7.2.4) and clean them using ultrasound in distilled water or another solution agent, for dissolving the buffers used. You may also try a combination of a water bath with an inorganic/organic or a polar/nonpolar solvent.

### 9.6. Cleaning Cell Windows

Contamination of the cells results in lowered light transmission, which increases the noise level and makes difficult at zeroing.

The simplest cleaning method is flushing dismantled cell with suitable solvents. **The cell must be taken out of the instrument before washing.** Select the solvent type according to the character of contamination by a series of mutually miscible solvents. It is possible to use both





organic and inorganic solvents and diluted solutions of acids (e.g. H<sub>2</sub>SO<sub>4</sub> or HNO<sub>3</sub> diluted with distilled water in ratio 1:20 to 1:10).

After this operation is completed flush the cell with pure solvent. Connect the cell to the system. While a liquid is flowing through it, observe the cell to see whether it leaks.

If cleaning procedure by flushing did not help, contact the service center.











## 10. SPARE PARTS AND ACCESSORIES

### SPARE PARTS

P/N	Picture	Description
<b>Spare parts</b> (basic spare parts)		
2052B90000		Halogen lamp with a cable and connector
MDTA1200		Deuterium lamp for TOYDAD-L + TOY14 + TOY18
ACE98100		PE Mobile Phase Filter 20 µm No-Met with reduction UNF 5/16"-24 (for inlet tubing ECP2300)
990436		Piston seal 3/8" U-R325 HB (CC)-204-GFP-HST (working head seal; Teflon with graphite; high chemical resistance; lower abrasion resistance, for pump 300 ml/min)
990437		Piston seal 3/8" U-325 MB-204-T-316 (PTFE washing head seal, for pump 300 ml/min)
990430		Piston seal 3/8" U-R325 HB (CC)-204-UHMWPE40-HST (working head seal; high molecular weight polyethylene; lower chemical resistance; high abrasion resistance, for pump 300 ml/min)
00525		Piston seal 20 mm GFP55HT (working head seal; Teflon with graphite; high chemical resistance; lower abrasion resistance, for pump 1000 ml/min)
00519		Piston seal 20 mm UHMWPE (working head seal; high molecular weight polyethylene; lower chemical resistance; high abrasion resistance, for pump 1000 ml/min)
00524		Piston seal 20 mm UHMWPE (UHMWPE washing head seal, for pump 1000 ml/min)
PJ250000		Preparative check valve 1/8" (for high flow rate, for pump 300 ml/min)







P/N	Picture	Description
PJ200070		Check valve holder UNF 5/16"-24 (for pump 300 ml/min)
PJ230000		Piston with holder (piston diameter 3/8", for pump 300 ml/min)
ACM40000		Preparative check valve 1000 ml/min" (for high flow rate, for pump 1000 ml/min)
ACM00060		Outlet check valve holder UNF 5/16"-24 (for pump 1000 ml/min)
ACM00050		Inlet check valve holder UNF 5/16"-24 (for pump 1000 ml/min)
ACM21200		Ceramic piston with spring and positioning parts (piston diameter 20 mm, for pump 1000 ml/min)
12480		Stainless steel spring, 75/47/3 (for piston, for pump 1000 ml/min)
00248		O – ring ID 4,47 mm, cross section 1.78 mm, Kalrez® (seal to degassing/purging valve, for pump 300 and 1000 ml/min)
PG252000		Needle degassing/purging valve, PEEK (for pump 300 and 1000 ml/min)
ACA20140		Leveling head seal KEL-F (seal under degassing/purging valve head, for pump 300 and 1000 ml/min)
ACE21001		Pressure sensor 60 MPa preparative (for pump 300 ml/min)
ACM50000		Pressure sensor preparative (for pump 1000 ml/min)



P/N	Picture	Description
3M066095		Timing belt wide 9,5 mm, 66 teeth (for pump 300 ml/min)
990673		Timing belt HTD8 60 teeth, 20 mm wide (for pump 1000 ml/min)
990671		Timing belt HTD5 72 teeth, 15 mm wide (for pump 1000 ml/min)
990695		Timing belt HTD5 105 teeth, 9 mm wide (for pump 1000 ml/min)
ACC21001		Motor of pump K 50, 100, 300 (when ordering, note unit serial number and pump type, for pump 300 ml/min)
ACM23000		Motor with a pinion (when ordering, note unit serial number and pump type, for pump 1000 ml/min)
EKAB-024		Sériový kabel, 9 pinů RS232 (2x DB9 samička, délka cca 2 m)
SCK41000		Capillary 1/8" 200 mm connecting pump 300 ml/min with sample switching valve (stainless steel capillary, OD=1/8", ID=2.1 mm, volume = 693 µl, 2x stainless steel nut 1/8", UNF 5/16"-24, 2x stainless steel ferrule 1/8")
SCK40000		Capillary 1/8" 305 mm connecting pump 1000 ml/min with sample switching valve (stainless steel capillary, OD=1/8", ID=2.1 mm, volume = 1056 µl, 2x stainless steel nut 1/8", UNF 5/16"-24, 2x stainless steel ferrule 1/8")
SCK42000		FEP tubing 1/4" 385 mm connecting gradient valve with pump 1000 ml/min (FEP tubing, ID=5/32", volume=4.8 ml only tubing, 2x CTFE nut 1/2", 2x CTFE ferrule 1/4", thread 1/2"-20 UNF, for gradient valve to solvent pump 1000 ml/min)





**CAPILLARY AND OPTIONAL PARTS FOR CONNECTING SAMPLE SWITCHING VALVE WITH COLUMN – REDUCTION 1/8" ON 1/16" – AND COLUMN WITH DETECTOR**

P/N	Picture	Description
<b>Optional Accessories</b>		
JR626-00		SS Tubing OD 1/8" x ID 2.1 mm, l = 1 m (outlet tubing)

P/N	Picture	Description
00000160		SS Nut 1/8", 5/16"-24 UNF threads (for outlet tubing)
JR-ZF2S6		SS Ferrule 1/8" (for outlet tubing)
JR625-40		SS capillary injection valve-column OD 1/16" x ID 1 mm
00000120		SS nut 1/16", UNF 10-32 threads
00000080		SS Ferrule 1/16"
JR60031		PEEK capillary grey OD 1/16"x ID 1mm
00000121		PEEK compact nut 1/16", UNF 10-32

PREPARATIVE CELLS

Cell	P/N	Picture	Description
<b>Optional Accessories</b>			
<b>Low Pressure (up to 2 MPa)</b>			
PLCC 3L L	ANA9203X		<b>Optical path:</b> 0.3 mm <b>Internal volume:</b> 80 µl <b>OD:</b> 3/16" <b>Thread:</b> 5/16"-24 <b>Max. flow rate:</b> 3000 ml/min
PLCC 07 L	25L0000X		<b>Optical path:</b> 0.3 mm <b>Internal volume:</b> 40 µl <b>OD:</b> 1/16" <b>Thread:</b> 10-32 <b>Max. flow rate:</b> 500 ml/min
PLCC 15 L	ANA9400X		<b>Optical path:</b> 0.3 mm <b>Internal volume:</b> 40 µl <b>OD:</b> 1/8" <b>Thread:</b> 1/4" – 28 <b>Max. flow rate:</b> 500 ml/min
PLCC 17 L	ANA9300X		<b>Optical path:</b> 1.3 mm <b>Internal volume:</b> 55 µl <b>OD:</b> 1/8" <b>Thread:</b> 1/4" – 28 <b>Max. flow rate:</b> 500 ml/min

Cell	P/N	Picture	Description
PLCC 19 L	ANA9400X		<b>Optical path:</b> 2.4 mm <b>Internal volume:</b> 70 $\mu$ l <b>OD:</b> 1/8" <b>Thread:</b> 1/4" – 28 <b>Max. flow rate:</b> 500 ml/min
PLCC 07 L PEEK	25LP000X		<b>Optical path:</b> 0.3 mm <b>Internal volume:</b> 40 $\mu$ l <b>OD:</b> 1/16" <b>Thread:</b> 10-32 <b>Max. flow rate:</b> 500 ml/min
PLCC 15 L PEEK	ANA94L0X		<b>Optical path:</b> 0.3 mm <b>Internal volume:</b> 40 $\mu$ l <b>OD:</b> 1/8" <b>Thread:</b> 1/4" – 28 <b>Max. flow rate:</b> 500 ml/min
PLCC 17 L PEEK	ANA93L0X		<b>Optical path:</b> 1.3 mm <b>Internal volume:</b> 55 $\mu$ l <b>OD:</b> 1/8" <b>Thread:</b> 1/4" – 28 <b>Max. flow rate:</b> 500 ml/min
PLCC 19 L PEEK	ANAL000X		<b>Optical path:</b> 2.4 mm <b>Internal volume:</b> 70 $\mu$ l <b>OD:</b> 1/8" <b>Thread:</b> 1/4" – 28 <b>Max. flow rate:</b> 500 ml/min
<b>High Pressure (up to 30 MPa)</b>			
PLCC HP08 L PEEK	ANAHP080		<b>Optical path:</b> 1 mm <b>Internal volume:</b> 8 $\mu$ l <b>OD:</b> 1/8" <b>Thread:</b> 5/16"-24 <b>Max. flow rate:</b> 3000 ml/min
PLCC HP16 L PEEK	ANAHP160		<b>Optical path:</b> 1 mm <b>Internal volume:</b> 18 $\mu$ l <b>OD:</b> 1/16" <b>Thread:</b> UNF 10-32 <b>Max. flow rate:</b> 500 ml/min

## 11. WARRANTY AND POST-WARRANTY REPAIRS

Warranty and post-warranty repairs are provided by the manufacturer or dealer organization authorized by company ECOM to do this work.

The repair of products in the warranty period carried out by any other person than that authorized by the service organization constitutes grounds for warranty nullification.

The scope of the warranty and its duration is given in the Certificate of Warranty.

Manufacturer:

**Ecom spol. s r.o.**

Trebonicka 239

252 19, Chrastany u Prahy

Czech Republic

Tel.: + 420 221 511 310

Fax: + 420 242 498 212

E-mail: [info@ecompro.cz](mailto:info@ecompro.cz)

[www.ecompro.com](http://www.ecompro.com)

## 12. CELL

### 12.1. Preparative cell PLCC 3L L

**Note:** Optical path can be adjusted by different orientation of windows, as shown earlier. Optical path 0.3 mm was adjusted in the manufacturing plant by combination of FEP sealing of various thickness (there may be even two on one side), and by special testing. **Therefore, when adjusting this optical path, address to your supplier.**



The unique design of the cell allows you to change optical path according to particular conditions of analysis from 0.1 to 3.9 mm. Cell volume is 80, 100 a 120  $\mu$ l respectively, according to the adjusted optical path. Maximum flow rate is 3000 ml/min. The cell is designed for preparative or TOY applications. Inlet tubing of OD 3/16" can be connected using a threaded screw UNF 5/16"-24 and a ferrule.

**Required test cell for PLCC 3L L is ZK 04 L.**

Stepwise arrangement of the cell windows makes possible to change the optical path of the cell in a simple way, by means of changing the positions of the windows and the gasket thickness. A by-pass formed by the windows and internal diameter of the cell forms free space securing a high flow through the measuring cell even in this arrangement. We recommend not to replace the cell windows. If it's necessary to change the optical path of the cell, please contact your distributor.



**Note: If you need to purchase a cuvette with a different optical path, please contact your distributor or manufacturer**

#### ORDER OF CELL COMPONENTS



Components of the **preparative** cell in the order as they are assembled:  
 1. 4x nut, 2. cell cover, 3. PLCC window, 4. PTFE sealing, 5. cell body, 6. 4x screws.

## 13. TECHNICAL PARAMETERS

The chromatography separation system consists of these parts:

### PUMP ECP2300/ECP201L

Parameter	Value	
	ECP2300	ECP201L
Flow rate	0.6-300 ml/min	2-1000 ml/min
Pumping system	Two plungers diameter 3/8" connected in parallel	Two plungers diameter 20 mm connected in parallel
Maximum operating pressure	15 MPa (2176 psi)	15 MPa (2176 psi)
Precision of the pressure measurement	± 2 %	
Flow rate setting	step 0.1 ml/min	step 1 ml/min
Repeatability of flow-rate adjusting <b>ECP2300</b> - (150 ml/min, 7,5 MPa, H <sub>2</sub> O) <b>ECP201L</b> – (500 ml/min, 7.5 MPa, H <sub>2</sub> O)	± 0,5 %	± 1 %
Accuracy of flow rate setting	± 2 %	
Upper pressure limit	1-15 MPa (2176 psi)	
Wetted materials	Stainless steel, PEEK, Tefzel™, Kalrez®, ruby, ceramic, seals*	
Output capillary volume from the sample dosing pump (to the injection valve) OD 1/8" x ID 2.1 mm, L=200 mm	693 µl	
Output capillary volume from the gradient solvent pump (to the injection valve) OD 1/8" x ID 2.1 mm, L=305 mm	1056 µl	

\*Seals material: default is GFP (PTFE), optional is UHMW-PE, more information upon request.

### GRADIENT VALVE

Parameter	Value
Number of valves	4 (A, B, C, D,)
Wetted materials	FFKM, PEEK
Setting of components concentration	0 – 100 %
Maximum operating pressure	2 MPa (290 psi)
Liquid temperature	5 to 55 °C

### DETECTOR TOY18DAD800L (SCANNING)

Parameter	Value
Wavelength range	200-800 nm (256 elements on CCD)
Number of channels	4
Scan	200-800 nm, do 20 Hz, with step 1 nm
Typical spectral half-width	10 nm
Accuracy of adjustment / Reproducibility	± 1 nm / ± 0,5 nm

Parameter	Value
Noise level at test cell (254 nm, TC 0.75 s)	5 x 10 <sup>-5</sup> AU
Drift at test cell (254 nm after 1 hour.)	1 x 10 <sup>-3</sup> AU/hr
Materials in contact with mobile phase	FEP, fused silica, stain steel, PEEK
Time constant	0.5 s, 0.75 s, 1.0 s, 2.0 s, 4.0 s, 8.0 s, 16.0 s, 0.2 s, 0.1 s
Output FEB tubing from column to detector OD 1/8" x ID 1/16", L=1 m	2 ml
Output FEB tubing from detector to fraction collector OD 1/8" x ID 1/16", L=350 mm	0.7 ml

### FRACTION COLLECTOR

Parameter	Value
Number of positions	10
Max. operating pressure	1.72 MPa (250 psi)
Max. flow-rate (water)	1000 ml/min
Max. temperature	75°C
Orifice	1,5 mm (0,060")
Connecting thread	1/4"-28, flat bottom
Wetted materials	FEP, PEEK, CTFE, PPS, Valcon E2
Inlet/outlet tubing	FEP tubing OD 1/8" x ID 1/16"

### PC TECHNICAL PARAMETERS

Parametr	Hodnota
Main board	3.5" Board Intel® Celeron® Processor N3160SBC (1.66GHz/2.24GHz/4Core)
System Memory	SO-DIMM DDR3L-8 GB
Ports	2x USB 2.0; 2x USB 3.0; 2x Ethernet 10/100/1000 Mbps; 2x RS232
Display	1x VGA; 1x HDMI
Storage	SSD 120GB

### CHROMATOGRAPHY SEPARATION SYSTEM

Parameter	Value	
	A338E	A3L8E
Output capillary from switching valve to column OD 1/8" x ID 2.1 mm, L=1 m	3.464 ml	
Orifice of the switching valve	1.7 mm (0,067")	
Max. operation pressure of switching valve	34 MPa (5000 psi)	
Switching valve wetted material	Stainless steel, Nitronic 60, Valcon H	
Communication	5x USB, 2x LAN, 2x RS232	
Power supply	100–240 V AC, 50/60 Hz	

Parameter	Value	
	A338E	A3L8E
Power input	490 W	
Dimensions (W x H x D)	405 x 490 x 525 mm (15.94 x 19.29 x 20.67")	
Weight	50 kg (110.2 lb)	55 kg (121.3 lb)
Operational environment conditions	Indoor use only. Altitude: do 2000 m Temperature: 5-40 °C Humidity: max. relative humidity 80 % for temperatures up to 31 °C decreasing linearly to 50 % rel. humidity at 40 °C. Voltage fluctuations: up to ± 10 % of nominal voltage. Overvoltage category II. Pollution degree 2.	



## 14. APPENDIX 1 – DECLARATION OF CONFORMITY

We,  
ECOM spol. s r.o.  
Trebonicka 239, CZ-252 19, Chrastany  
Czech Republic  
Company ID No.: 41 192 192

as the manufacturer declares, that the product meets all applicable provisions of the EU directive on electromagnetic compatibility Government Decree No.117/2016 Coll. (Directive 2014/30/EU) and all applicable provisions of the EU low voltage directive Government Decree No.118/2016 Coll. (Directive 2014/35/EU), as well as Restriction of the use of Certain Hazardous Substances (RoHS-2) 2011/65/EU.

**Product:** Chromatography separation system  
**Model:** PREPBOXA3L8E

Contextual models: PREPBOX A338E

Application of the product: The equipment is used in the lab for the injection of sample, switching mobile phase delivery from different pumps, sample collecting during chromatographic analysis

Manufacturer: ECOM spol. s r.o., Trebonicka 239, CZ-252 19, Co. ID No.: 41192192

The following technical standards were applied when evaluating conformity:

EN 61010-1 ed.2:2011 + A1:2019 (idt IEC 61010-1:2010+A1:2016+COR1:2019),  
EN 61000-6-3 ed.2:2007+A1:2011 + Cor.1:2013 (idt: EN 61000-6-3:2007/A1:2011/AC:2012),  
EN 61000-3-2 ed.5:2019 (idt IEC 61000-3-2:2018),  
EN 61000-3-3 ed.3:2014 (idt IEC 61000-3-3:2013),  
EN 61000-6-1 ed.3:2019 (idt IEC 61000-6-1:2018),  
EN 61000-4-2 ed.2:2009 (idt IEC 61000-4-2:2009),  
EN 61000-4-8 ed.2:2010 (idt IEC 61000-4-8:2010),  
EN 61000-4-4 ed.3:2013 (idt IEC 6100-4-4:2012),  
EN 61000-4-11 ed. 3:2020+ A1:2017 (idt IEC 61000-4-11:2004/A1:2017).

Evaluation of conformity was performed by company TÜV SÜD Czech, s.r.o with the certified quality system according to ČSN EN ISO 17020 which issued the following reports:

Inspection report for electromagnetic compatibility No. 15.345.828-1

Inspection report for electrical equipment safety No. 15.345.828-2

Prague 22.08.2023



**Ing. Jan Fara, PhD.**  
CEO

## 15. APPENDIX 2 – PREPBOX A338E / A3L8E WITH ADDITIONAL SWITCHING VALVE

The PREPBOX A338E / A3L8E are the default versions. At the customer's request, the types of switching dosing valve and multi-positions selector valve (the fraction collector) can be modified.

The centrifugal partition chromatography (CPC) process may be more suitable for preparative purification, particularly in terms of yield and scalability. One additional switching valve (2 positions, 4 ports) is added for this purpose. This switches the pumping of the mobile phase and the stationary phase into the CPC instrument.

**FRONT VIEW UNIT WITH ASCENDING / DESCENDING VALVE**



No.	Description
1	Ascending / descending valve

*Other parts of unit are described in chapter 3.*

PREPBOX WITH ADDITIONAL SWITCHING VALVE FOR CPC

